

## ALLTY 1500 USER MANUAL

### ACCESSORY/STRUCTURE

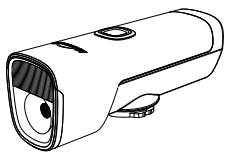

ALLTY 1500



Handlebar mount

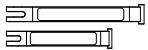

Aero bar compatible strap

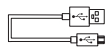

Micro USB Cable



3mm Hex

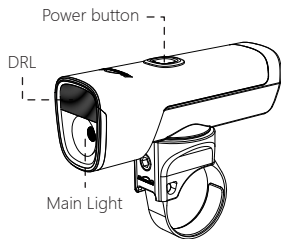

Power button

DRL

Main Light

### HOW TO INSTALL

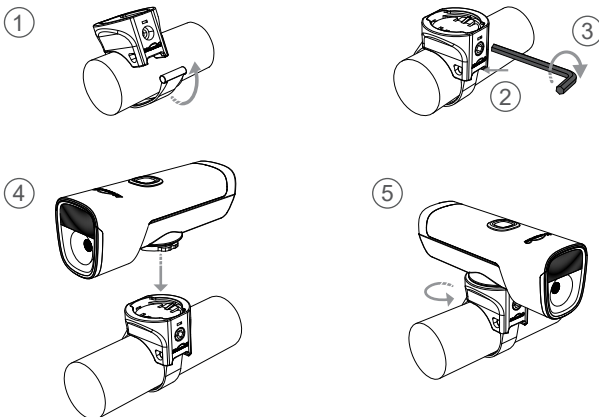

### BATTERY INDICATOR

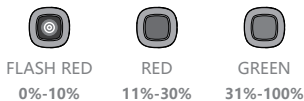

FLASH RED  
0%-10%

RED  
11%-30%

GREEN  
31%-100%

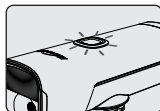

### HOW TO RECHARGE



RED  
Charging



GREEN  
Fully charged

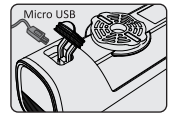

Standard charging time  
Approx. 5.5hrs (5V 1A)

### SWITCHING THE LIGHTING MODE

Hold 1s power button to turn on/off

When you turn the light on, it lights up in the last lighting mode you used.

(Mode memory function)

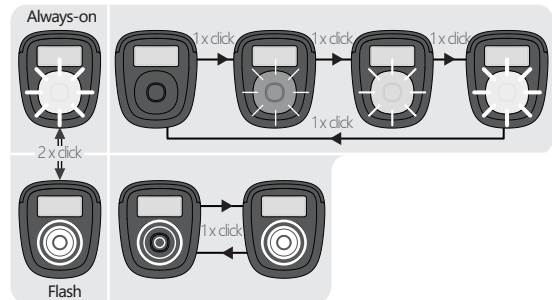

### LUMENS/RUN TIME

MODE	DRL	LOW	MID	HIGH	FLASH 1	FLASH 2
LUMENS	25	350	750	1500	0-1000	0-500
h:min	30:00	11:30	04:30	02:00	09:30	10:00

### OPTIONAL PARTS

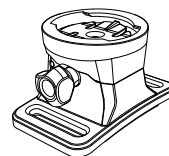

Helmet mount

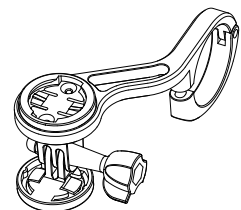

TTA front mount

\*Adaptable accessories (sold separately)

### ⚠ WARNING



## **EN WARRANTY**

---

The Magicshine lighting system is warrantied for 24 months from the date of purchase.

If you register the lighting system on the Magicshine website you will receive a bonus 6 month warranty.

Battery packs and AC adapters have a 6 month warranty, however, there is no bonus warranty available.

The warranty is limited to defects in material and workmanship on the lighting system itself, the battery pack and the AC adapter.

The warranty is only valid if the affected parts have not been tampered with and there is no intentional damage. Please keep your proof of purchase in a safe place. Proof of purchase must be presented in the event of any claim. Please contact the specialist retailer from whom you purchased the device for complaint or warranty claim.

Alternatively, you can send your complaint or claim directly to Magicshine at

Tel: (+86) 755-295 536 69

Fax: (+86)755-275 897 77

**E-mail: [support@magicshine.com](mailto:support@magicshine.com) (order from [Magicshine.com](http://Magicshine.com) online store)**

**[service@magicshine.com](mailto:service@magicshine.com) (order from other sales channels)**

In the event of a justified warranty claim and delivery of a replacement device, you will only be entitled to a model available when replacing.

The manufacturer retains the right to make technical modifications.

### **ANSI FL 1 STANDARD**

