

### SH47

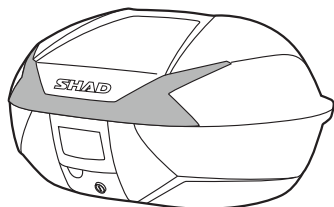

### SH46

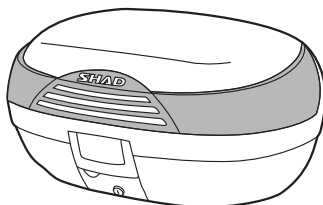

### SH45

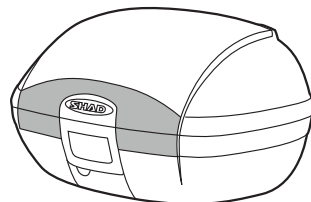

### SH42

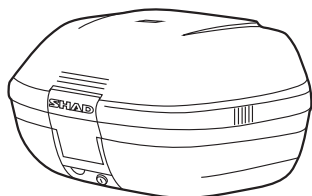

### SH40

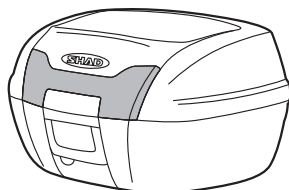

### SH40 CARGO

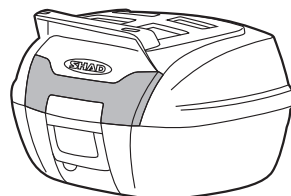

## ACCESSORIES (OPTIONAL)

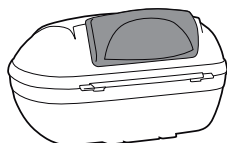

Backrest

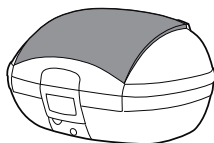

Colour cover



Brake light  
Ref. D0B40KL

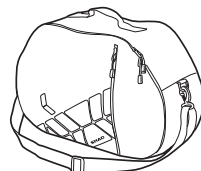

Inner Bag  
(SH42, SH45, SH46, SH47)

Find out about other products at

[WWW.SHAD.ES](http://WWW.SHAD.ES)

# OPEN

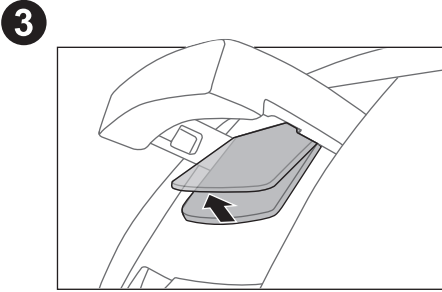
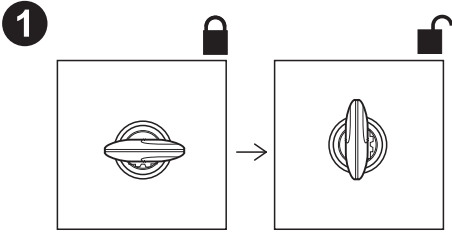

2

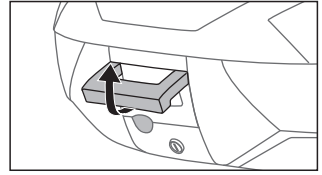

4

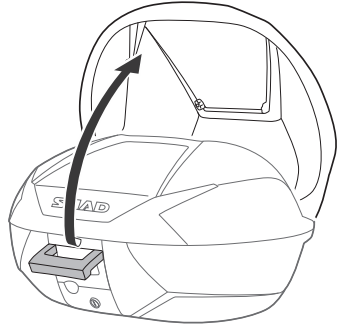

# ASSEMBLY

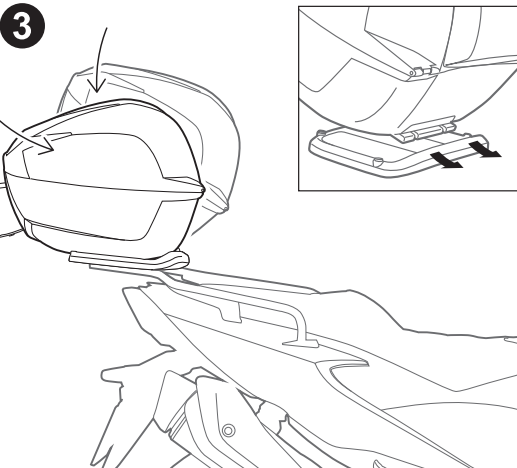
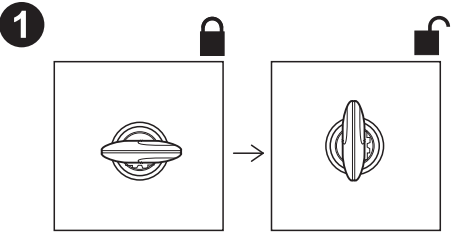

2

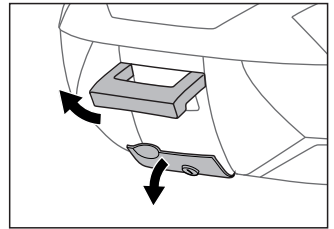

4

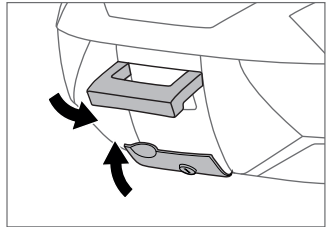

5

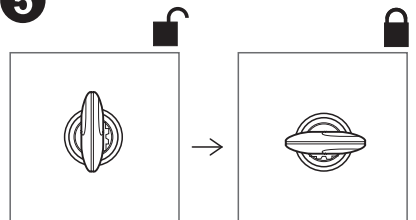

**CLOSE**

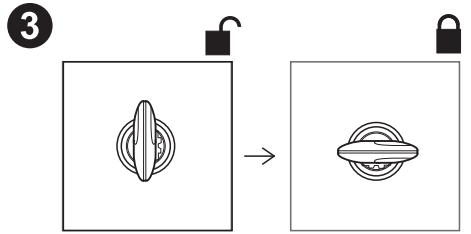
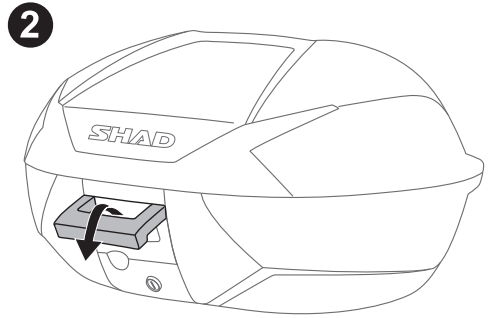
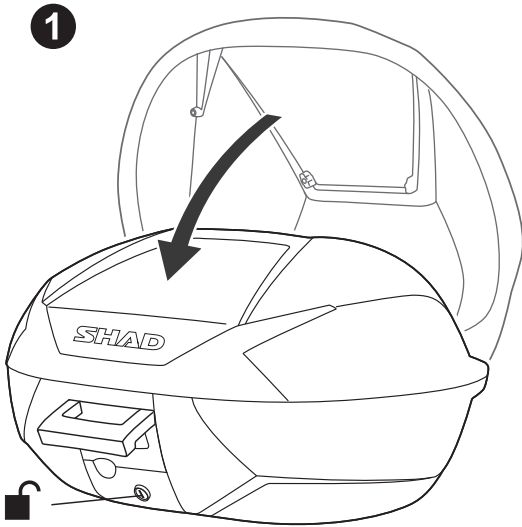

**RELEASE**

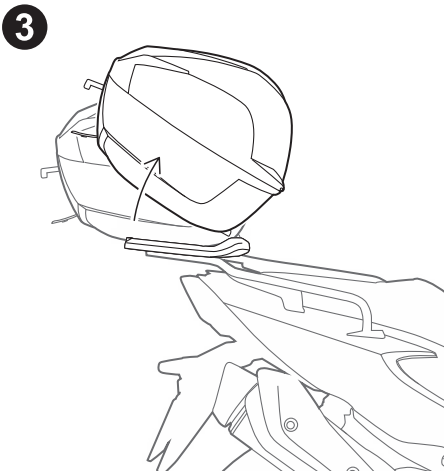
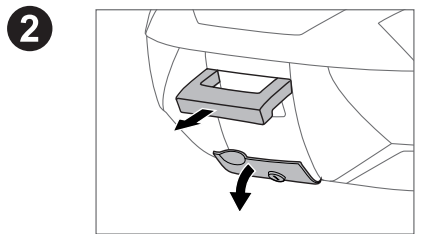
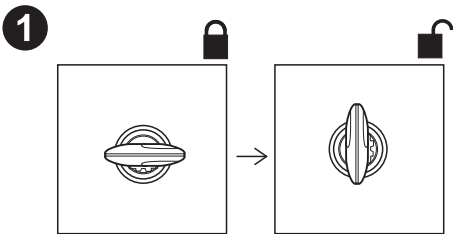

**SH40 Cargo**

\* Only for SH40 Cargo

#	Piece	Quantity
1	Clip	4
2	Screw	4
3	Washer	4

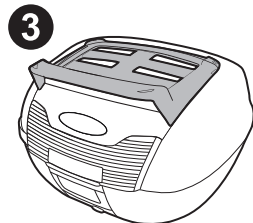
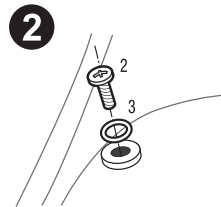
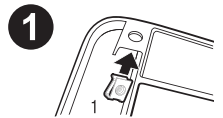

# TOP CASE SUPPORT ASSEMBLY

## Use top case parts

#	Piece	Quantity
1	Clip	4
2	Screw M6x40	4
3	Plastic spacer	4
4	Ø6 Washer M6	4
5	Nut M6	4
6	Screw M6x30	4

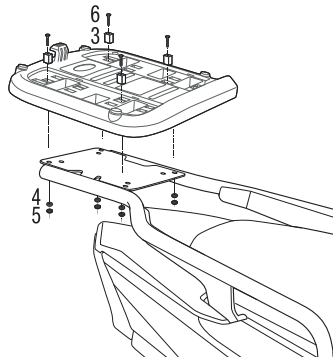
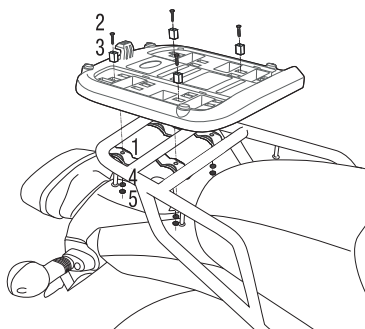
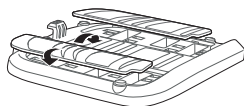

SHAD Top Master\*

## Use fitting kit parts

#	Piece	Quantity
7	Metal spacer	4
8	Screw M8x20	4
9	Washer M8	4
10	Nut M8	4



⚠ CHECK BIKE COMPATIBILITY  
WWW.SHAD.ES \*

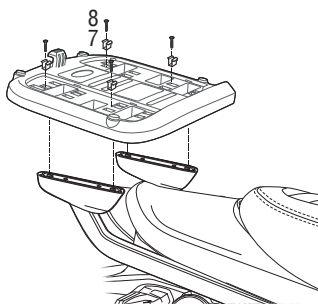

SHAD Top Master\*

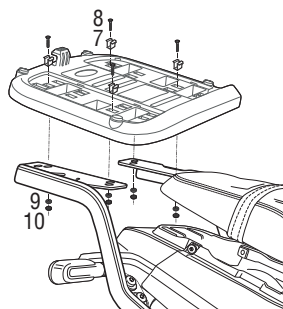

SHAD Top Master\*

## CARE AND MAINTENANCE



1 M. MINIMUM DISTANCE WITH POWER WASHER.



ALWAYS SECURE AND LOCK PRODUCTS.



MAXIMUM WEIGHT.  
(SH42, SH45, SH46, SH47)



CASES ARE NOT DESIGNED TO PROTECT FRAGILE OBJECTS.



MAXIMUM WEIGHT.  
(SH40, SH40 Cargo)



MAXIMUM SPEED, CHECK LOCAL LAWS.

**SHAD**  
WWW.SHAD.ES

Octave Lecante, 2-6  
Pol. Ind. Can Magarola  
08100 MOLLET DEL VALLÈS  
BARCELONA (SPAIN)

Phone: 0034 935 795 860  
Fax: 0034 935 796 945  
info@shad.es