

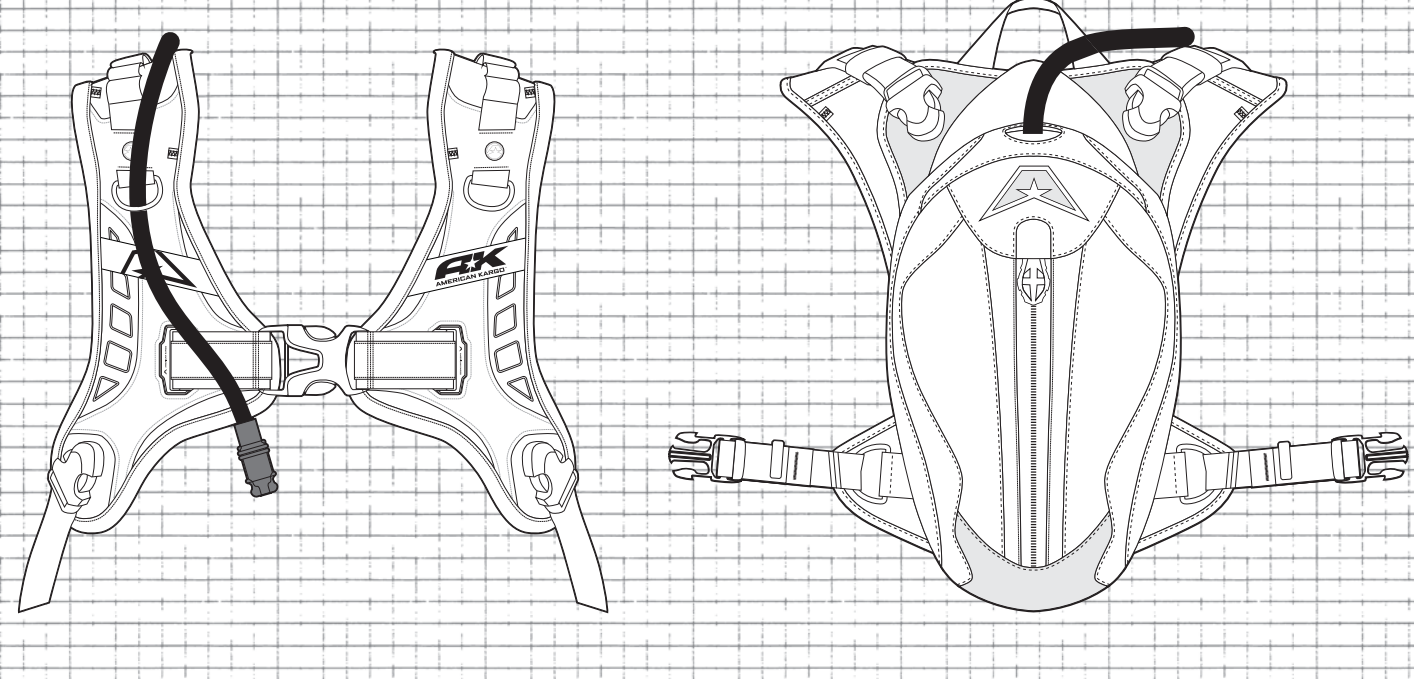

TURBO 1.5



DIMENSIONS: 13" h x 07" w x 04" d

FITMENT

Position the pack to sit in the center of your back with the shoulder straps snug but comfortable on the center of your shoulders. The chest harness should be adjusted to fit securely around your body.

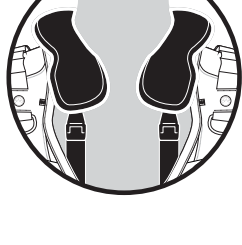

Designed to fit with a neck protector or roost guard.

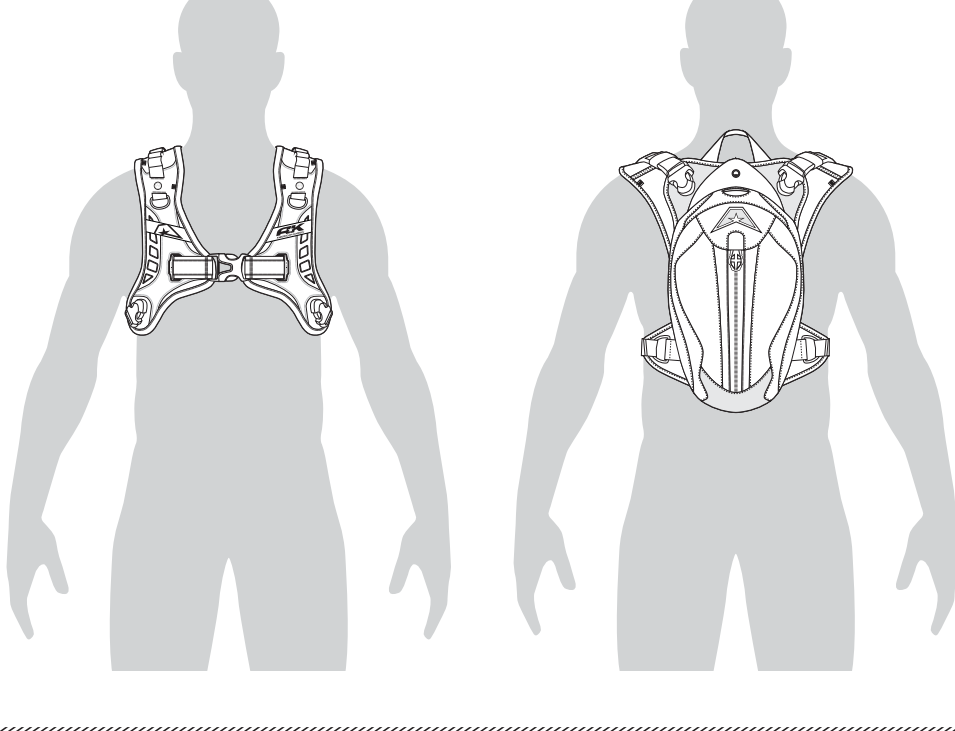

4-WAY ADJUSTABLE BUTTERFLY HARNESS

The key to the security and fit of the Turbo 1.5 is the 4-way adjustable butterfly harness. Once the pack is where you like it, tighten it down slowly, adjusting the straps as you go; bottom, top and chest. It might take a little practice, but once you get it, you know you're good.

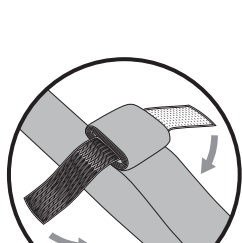

Roll up and secure loose straps with the strap keepers.

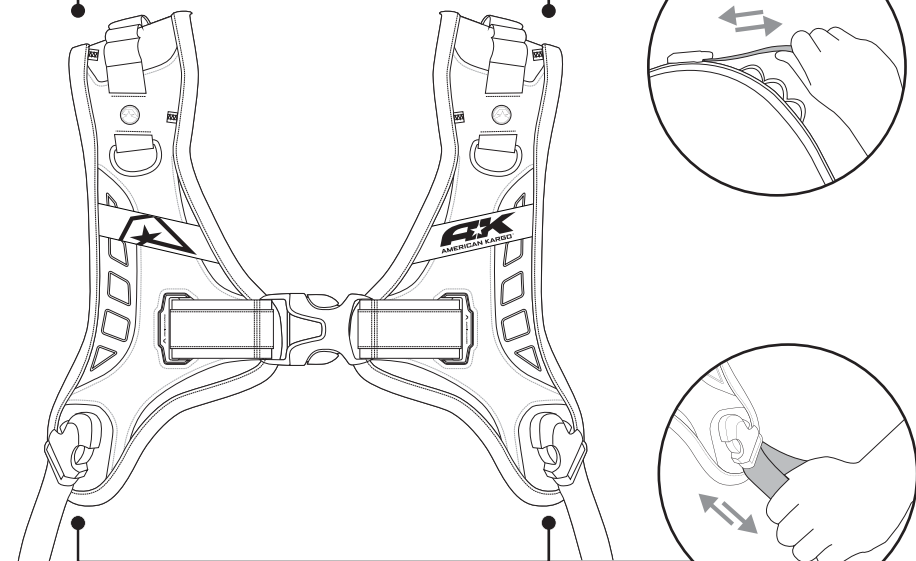

OVERHEAD RELEASE

Release the two lowest buckles of the butterfly harness. Once detached you can easily lift the pack over your head. If desired the sternum strap can also be detached to allow for even greater flexibility when removing the pack.

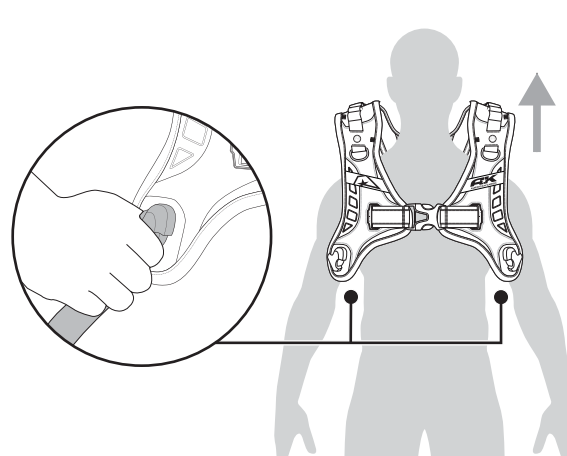

RETROFLECT

This unique material provides additional visibility in less than optimal riding conditions. Reflective and durable, Retroflect is integrated into the designs of American Kargo bags that are built for adventure.



All areas highlighted in grey are panels of retroflect material.

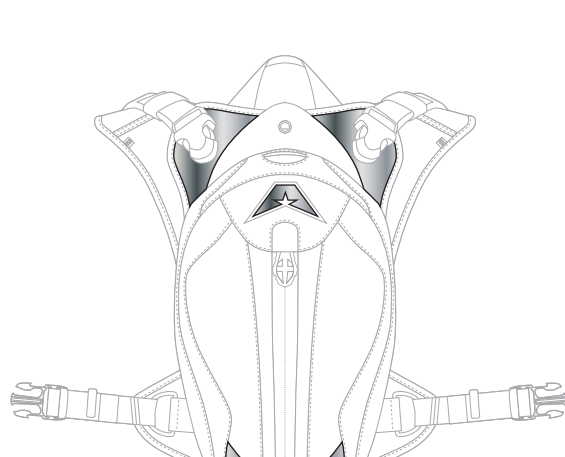

FEATURES

01 FLEECE LINED PHONE POCKET
Keep your phone safe while riding

02 INSULATED HYDRATION
Thermal lined bladder compartment

03 ADDITIONAL EXTERNAL STORAGE COMPARTMENT

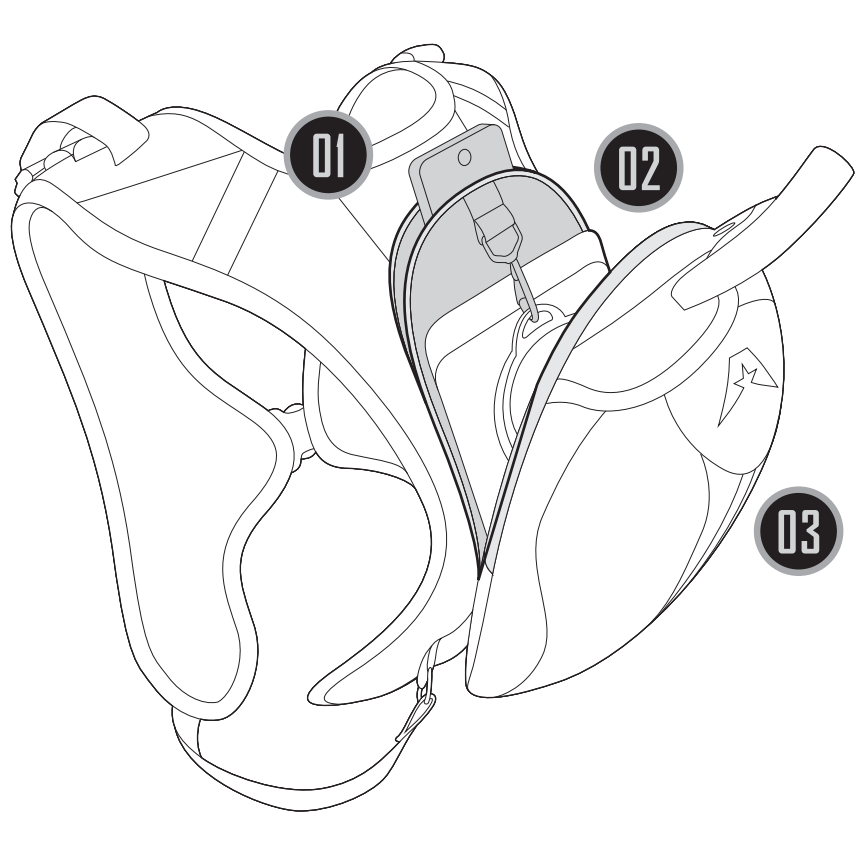

HYDRATION ROUTING

The Turbo 1.5 uses a 1.5L or 2L hydration bladder. To install, unclick the buckles at the top of the shoulder straps and unzip the hydration compartment. Slide the hydration bladder and hose into the hydration pocket. Route the hose through the slot located at the top center of the pack. Then route the hose through the D-ring on the chest harness and attach the hose to the velcro to keep it secure while riding.

The bladder has a wide mouth opening so that you can refill without removing from the bag.

To remove the bladder pull the hose back into the main compartment and remove as a single unit.

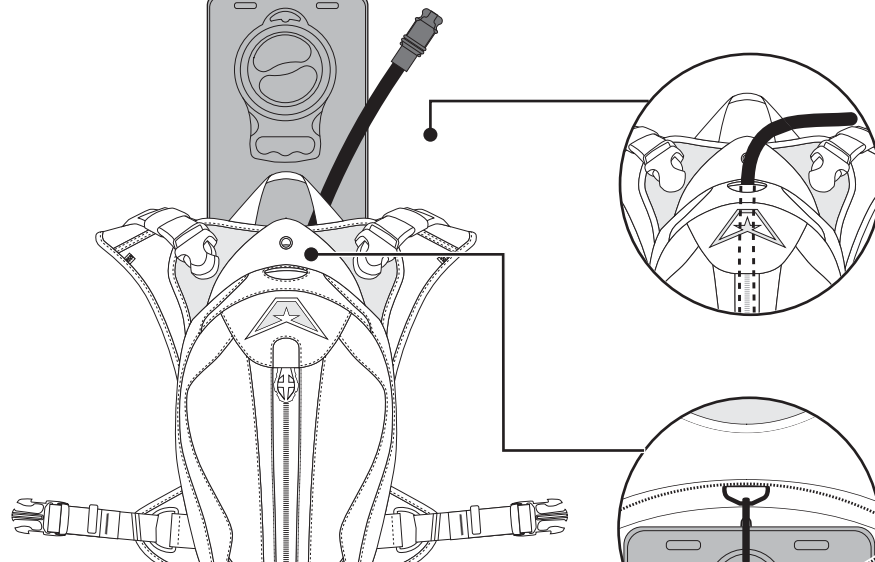

*HYDRATION SYSTEM CAN BE ROUTED THROUGH EITHER SIDE OF THE HARNESS

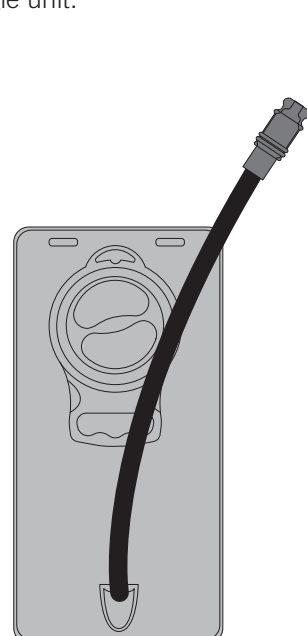

*COMPATIBLE WITH 1.5L AND 2L BLADDER

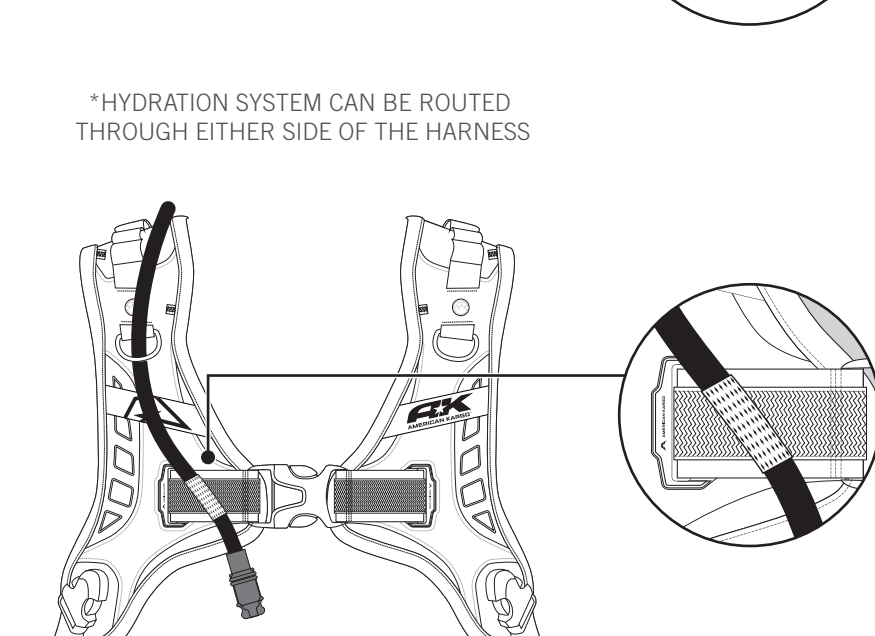

HYDRATION CLEANING

The best way to care for your reservoir is to clean and dry it after every use. However, if you don't clean it after every single use, and mold or discoloration happens to develop, you can still get it clean.

Use hot water and 2 tablespoons of baking soda or bleach. Mix the solution inside your reservoir and hold it up above your head while you pinch the bite valve, allowing the solution to run through the tube.

Let the reservoir and cleaning solution sit for about 30 minutes.

Wash the reservoir with hot water and mild soap. Be sure to completely rinse thoroughly.

Once the reservoir is clean, air dry the reservoir so no moisture is trapped inside, which can cause mold to grow.

These steps will make your reservoir safe for use again. If you still have spots left, they will never come all the way out because the reservoir is permanently stained, but, is still safe to use again.

AUDIO ROUTING

Run the audio wire through the top of your bag and onto whichever shoulder strap suits you.

The extension cord portion of the ear buds stays wired in the bag for easy setup.

*Ear buds not included
Use the AK Ear notepad for seamless integration.

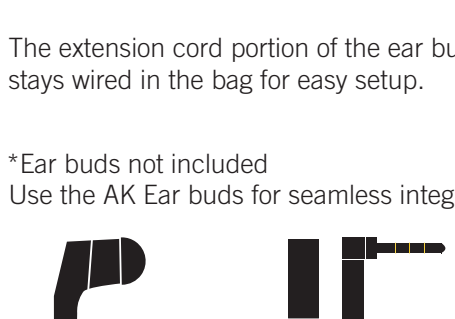

Ear buds

Extension Cord

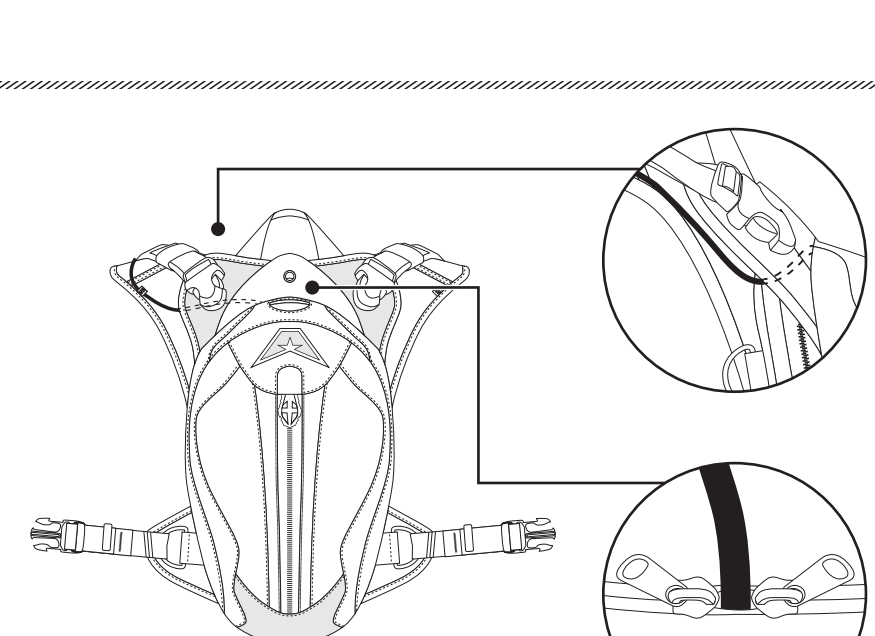

*AUDIO CAN BE ROUTED THROUGH EITHER SIDE OF THE HARNESS

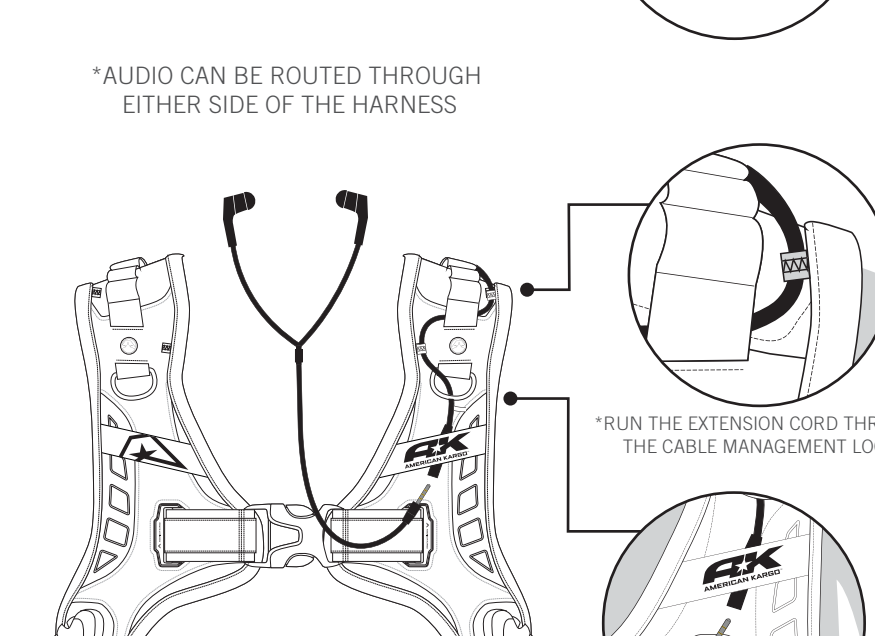

*RUN THE EXTENSION CORD THROUGH THE CABLE MANAGEMENT LOOPS

ZIPPERS

You can secure the zipper by sliding it under the elastic stretch band. For more aggressive riding fully lock it by flipping the zipper up and sliding it all the way through the elastic stretch band.

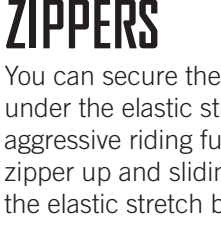

Oversized zipper pulls designed to work with gloves.

SEMI-LOCK

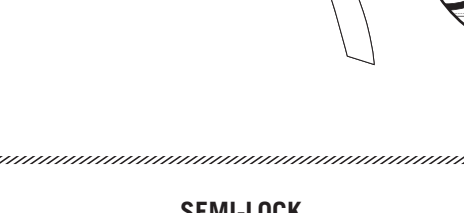

FULL-LOCK

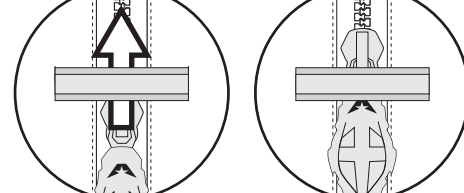

STORAGE

The American Kargo Turbo series was designed for storage on a traditional clothing hanger. After a hard day riding, hang your pack up along with the rest of your gear so its ready for your next adventure.

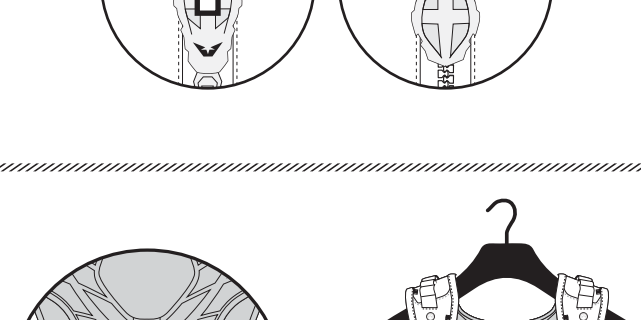

CARE AND CLEANING

The best way to keep your reservoir clean is with water. That's right, your AK bag requires almost no maintenance, other than periodic cleaning with water. If you discovered a way to get your bag so dirty that water alone isn't going to cut it, you can scrub the bag with a soft brush, mild soap and water to remove any dirt or residue.

We do not recommend the use of harsh solvents or chemicals to clean your bag as they can break down the materials in your bag and leave it faded. Once your bag is clean don't be tempted to place it in a dryer. Dryers can damage the protective coatings on your bag so we recommend that you hang it up to air dry.



WARRANTY

American Kargo provides lifetime warranty coverage for its luggage and accessory products to the items' original retail purchaser. The Lifetime Limited Warranty covers defects in materials, design or workmanship.

American Kargo will repair or replace, at their option, items that are defective. The purchaser is required to obtain advance return authorization and for shipping the affected item to American Kargo for warranty repair or replacement. Damage

caused by improper use or improper installation is not a defect; therefore repair or replacement of a damaged product will not be covered under this warranty.

This warranty has other provisions and conditions, so please review the coverage and return authorization information at www.americankargo.com for additional information. If you have any comments, or are not satisfied with the performance of your American Kargo accessory, please call us at (310) 761-8151.

