

# A2166A - A2166AK

ATTACCHI SPECIFICI PER - SPECIFIC FITTING KIT FOR - KIT DE MONTAGE SPECIFIQUE POUR  
SPEZIFISCHER MONTAGEKIT FÜR - ANCLAJE ESPECÍFICO PARA - ANCORADOURO ESPECÍFICO

## YAMAHA MT 125 (2020/2022)

N°	Descrizione-Description	Caratteristiche-Features	Codice-Code	Quantità-Quantity
1	Supporto - Support - Support Halterung - Soporte - Apoio	-	GL5477DXV GL5477SXV	2 (Right: Left)
2	Vite - Screw Vis - Schraube Tornillo - Parafuso	TBEIFN M6x16	616TBEIFN	4
3	Rondella In Nylon - Nylon Washer Rondelle Original En Nylon - Nylonscheibe Arandela De Nylon - Arruela De Nylon	Foro 6mm / Esterno 13mm / Sp. 0.2mm	Z1979	12
4	Rondella in gomma - Rubber washer Rondelle en gomme - Gummischeibe Arandela de goma	Foro 9mm / Esterno 16mm / Sp. 2mm	916RONG	4
5	Distanziale - Spacer Entretoise - Distanzstueck Distanciador - Espaçador	Ø9x5 Foro 6,5mm	C9L5F6,5T	4
6	Dado - Bolt - Erou Mutter - Tuerca - Porca	Dado Autobloccante Flangiato Ribassato M6 (H.7mm)	6DADIABFN	4
7	Tappo - Cap Fiche - Stecker Enchufe - Boné	-	10COP	4
8	Componenti Originali - Original Parts Parties Originales - Original Bauteile Componentes Originales - Componentes Originais	-	-	-
9	Schermo Specifico - Specific Screen Écran Spécifique - Spezifischen Bildschirm Pantalla Específica - Tela Específica	-	2166A	-

IT\_ Nel caso in cui sulle viti originali sia presente del frenafilletti, ripristinarlo durante il montaggio dell'accessorio.

EN\_ If there is threadlocker on the original screws, use threadlocker when mounting the accessory.

DE\_ Falls sich auf den Originalschrauben Schraubensicherungsstoff befand, sollte dieser auch bei der Montage des Zubehörs wieder aufgetragen werden

FR\_ Si du frein filet est présent sur les vis d'origine, l'appliquer également lors du montage de l'accessoire

ES\_ En caso de que el fijador de roscas se encuentre presente en los tornillos originales, colocarlo nuevamente en el montaje del accesorio

PT\_ Se houver trava rosca nos parafusos originais, inserir novamente durante a montagem do acessório

# A2166A - A2166AK

ATTACCHI SPECIFICI PER - SPECIFIC FITTING KIT FOR - KIT DE MONTAGE SPECIFIQUE POUR  
SPEZIFISCHER MONTAGEKIT FÜR - ANCLAJE ESPECÍFICO PARA - ANCORADOURO ESPECÍFICO

## YAMAHA MT 125 (2020/2022)

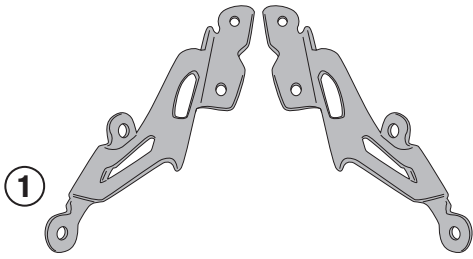

GL5477DXV / GL5477SXV

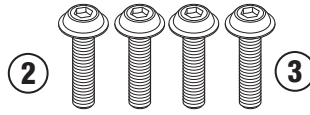

M6x16mm



Hole Ø6mm/  
External Ø13mm/  
D.0.2mm



Hole Ø9mm/  
External Ø16mm/  
D.2mm



Hole Ø6.5mm/  
External Ø9mm/  
H.5mm

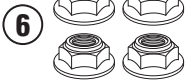

M6



10COP

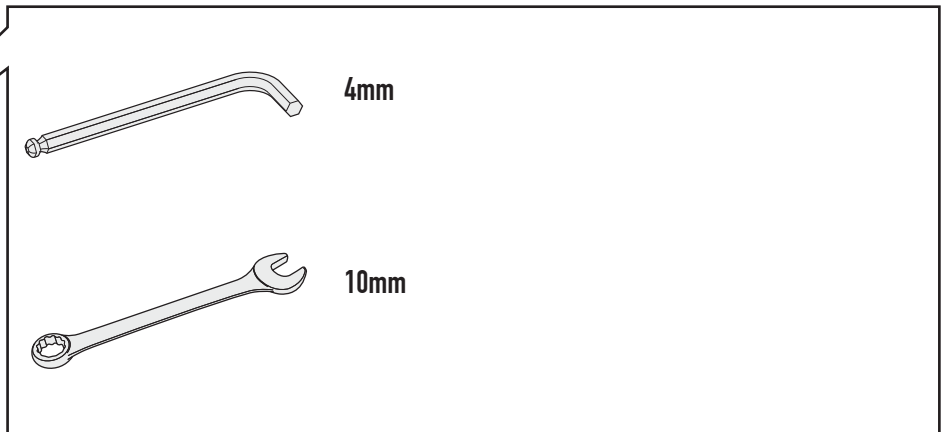
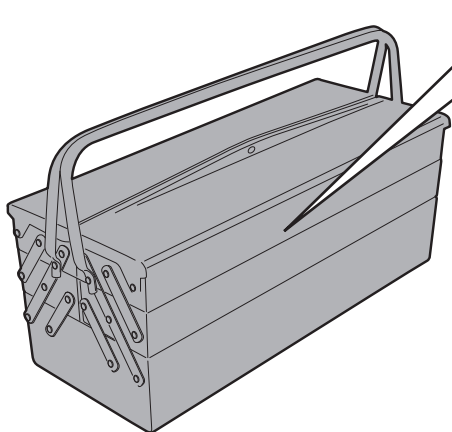

CHECK THE SCREW LENGTH HERE

ISTRUZIONI DI MONTAGGIO - MOUNTING INSTRUCTIONS  
INSTRUCCIONES DE MONTAJE - BAUANLEITUNG  
INSTRUCCIONES DE MONTAJE - INSTRUÇÕES DE MONTAGEM

# A2166A - A2166AK

ATTACCHI SPECIFICI PER - SPECIFIC FITTING KIT FOR - KIT DE MONTAGE SPECIFIQUE POUR  
SPEZIFISCHER MONTAGEKIT FÜR - ANCLAJE ESPECÍFICO PARA - ANCORADOURO ESPECÍFICO

## YAMAHA MT 125 (2020/2022)

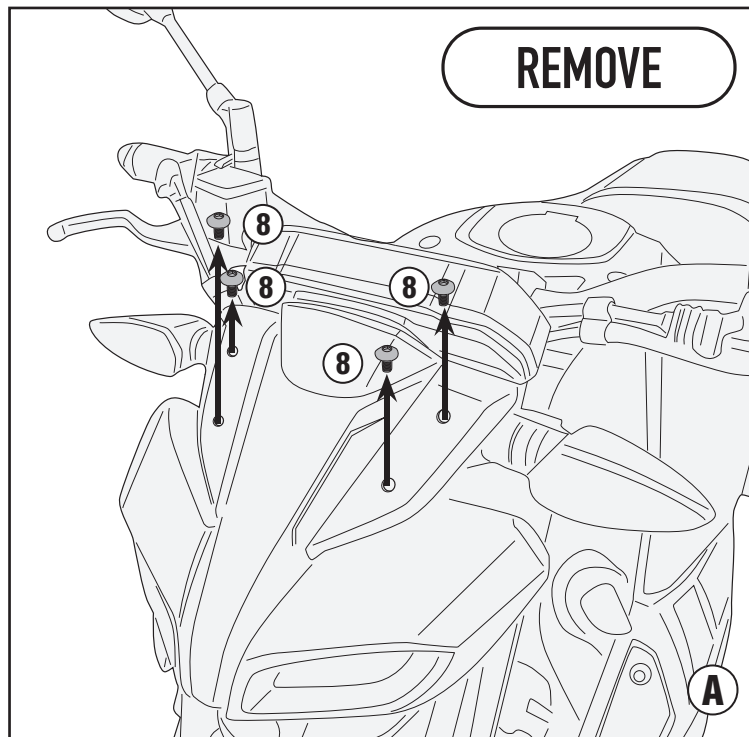
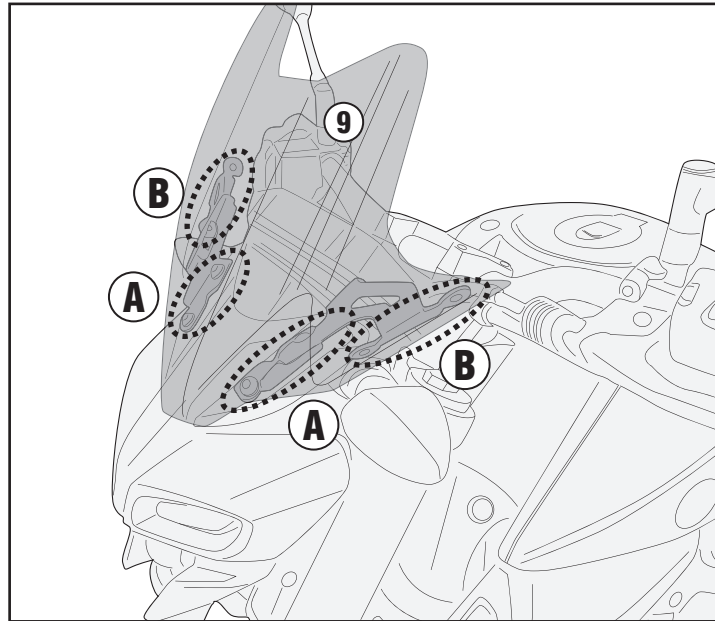

# A2166A - A2166AK

ATTACCHI SPECIFICI PER - SPECIFIC FITTING KIT FOR - KIT DE MONTAGE SPECIFIQUE POUR  
SPEZIFISCHER MONTAGEKIT FÜR - ANCLAJE ESPECÍFICO PARA - ANCORADOURO ESPECÍFICO

## YAMAHA MT 125 (2020/2022)

