

Items Supplied >

- 1 - Sissy Bar with Pad and Insert
- 2 - Detachable Side Plates (Left/Right) Chrome or Black
- 2 - 3/8" I.D. Front, Mount Bushing Chrome or Black
- 2 - 3/8" I.D. Rear, Outer/Inner/Plastic Bushing Chrome or Black
- 4 - 3/8"-16 x 1-3/4" Buttonhead Bolts Zinc
- 4 - M8 x 16 mm Buttonhead Bolts

Application(s) >

HARLEY:		
SOFTAIL:	FLSL	18-19
	FXBB	18-19
	FLDE	18-19

(ONLY ABOVE MODELS AS OF JUNE, 2018)

Instruction Manual >

602-2046 / 602-2046B

Page 1 of 3

Read all instructions carefully before installing your new Cobra® product!

1. Remove the front bolt from the right side fender rail and discard. **NOTE:** Remove one side only so the fender does not fall resulting in possible scratches or damage to the fender or paint. See **FIGURE 1**.
2. Install the front mounting bushing into the front hole using the supplied 3/8"-16 x 1-3/4" long buttonhead bolt and tighten bolt securely. See **FIGURE 2**.
3. Remove the right rear fender rail bolt and discard. See **FIGURE 1**. Install the rear supplied bushing as oriented in **FIGURE 2**, using the supplied 3/8"-16 x 1-3/4" long buttonhead bolt and tighten bolt securely.

REMOVE STOCK
REAR BOLT



REMOVE STOCK
FRONT BOLT

FIGURE 1

CONTINUED ON PAGE 2

* **Cobra® recommends you always wear a helmet while riding. Please never operate your motorcycle while under the influence of alcohol and/or drugs. Enjoy the new look of your motorcycle and please ride safely.**



FIGURE 2

4. Repeat Steps 1-3 on the left side.
5. Install the supplied side plates on to the sissy bar with the four M8 X 16 mm button head bolts. Make sure the u-shaped grommets are facing the same direction as the sissy bar pad and the part numbers are facing inward. See **FIGURE 3**. Snug the bolts but **DO NOT TIGHTEN** at this time.

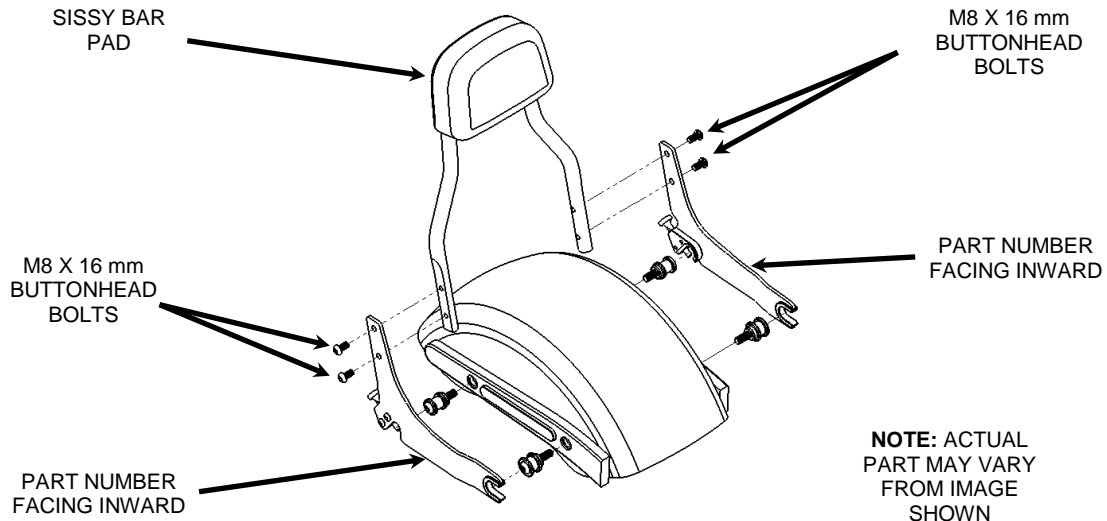

FIGURE 3

6. Install the sissy bar onto the bike by first inserting the front portions of the side brackets on to the front mounting bushings on the frame rails. Make sure the sissy bar is seated all the way onto the mounting bushings. See **FIGURE 4**.
7. Then slowly rotate the sissy bar downward so the rear portions of the brackets slip over the rear mounting bushings. See **FIGURE 4**.

CONTINUED ON PAGE 3

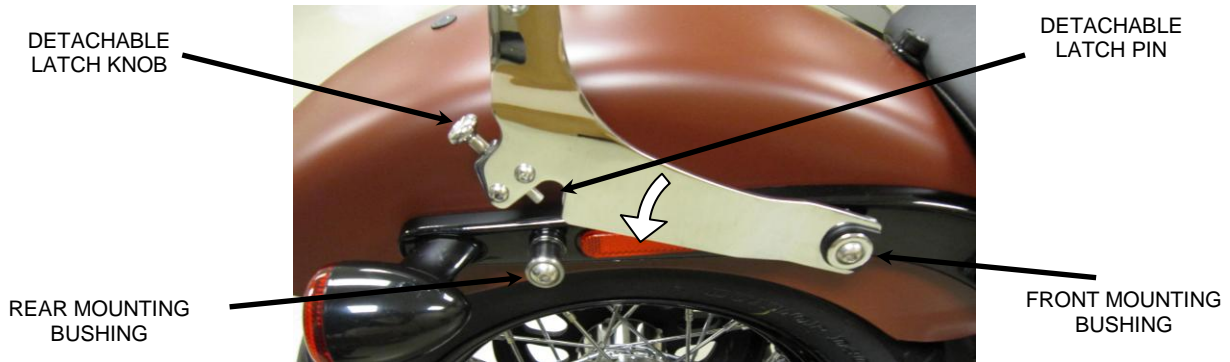

FIGURE 4

15. Pull backward on both detachable latch knobs and then push downward on the backrest to allow the backrest to sit completely on the rear mounting bushings. Then release the detachable latch knob to fully engage the latch pin underneath the mounting kit bushing. See **FIGURE 5**.
16. Always check to make sure both detachable latch pins are fully engaged on the bottom of the mounting kit bushing. Failure to fully engage the detachable latch pin could cause the backrest to come loose while riding. See **FIGURE 5**.
17. Pull backward on the top of the sissy bar and then tighten all four M8 X 16 mm bolts. See **FIGURE 5**.
18. Before each ride, check to make sure the detachable latches are fully engaged underneath the mounting bushings.
19. Check the tightness of all the screws after the first ride and after the first 500 miles.



FIGURE 5

To clean your black accessory use a liquid based soap detergent, such as dishwashing soap applied with a soft cloth and rinse with clean water. Note: Avoid abrasive cleaning methods such as granular or dry cleansers, simple green, Scotch-Brite or steel wool pads. Abrasives may breach the coating and shorten life.