

# ANBAUANLEITUNG

mounting instructions • instructions de montage • instrucciones de montaje • istruzioni di montaggio

## HDG.00.220.31800/B

beinhaltet • contains • contient • contiene • contiene

HDG.00.220.81801/B

HDG.00.220.10000/B

Art.-Nr.: HDG.00.220.81801/B

Revision: 00 · Datum: 01 - 2024

## Handprotektoren Montage-Kit

 ~ 0.5 h.

 LEICHT      SCHWER

**DEUTSCH** - Vielen Dank, dass Sie sich für dieses Premium-Produkt von SW-MOTECH entschieden haben. Besuchen Sie unseren Webshop für weitere Informationen (z. B. Modellzuweisungen). Erforderliche Dokumente (z. B. ABE) stehen Ihnen dort als Download zur Verfügung.

Bitte lesen und verstehen Sie alle Anweisungen, Sicherheitshinweise und Warnungen in dieser Anbauanleitung vor Montage und Nutzung des Produkts, um Verletzungen und Schäden zu vermeiden. Bewahren Sie diese Anbauanleitung als Referenz auf.

Dieses Produkt wurde für Fahrzeuge im Werkzustand entwickelt. Die Kompatibilität mit Original-Zubehörteilen bzw. den Zubehörteilen anderer Hersteller kann nicht gewährleistet werden.

Diese Anbauanleitung ist nach unserem derzeitigen Kenntnisstand verfasst worden. Rechtliche Ansprüche auf Richtigkeit bestehen nicht. Fehler und Irrtümer vorbehalten. Technische und gestalterische Änderungen sind vorbehalten. Das Urheberrecht liegt bei SW-MOTECH.

### SICHERHEITSWARNUNGSSYMBOL

 Dieses Warnsymbol wird in dieser Anbauanleitung verwendet, um vor tödlichen Gefahren, Verletzungen oder anderen Gefahren zu warnen. Die Wörter **GEFAHR**, **WARNUNG** oder **VORSICHT** werden mit diesem Warnsymbol verwendet, um wichtige Sicherheitshinweise und Informationen in Bezug auf die Montage und Nutzung dieses Produkts zu übermitteln. Diese Wörter zusammen mit dem Sicherheitswarnsymbol bedeuten:

**▲ GEFAHR:** Weist auf eine gefährliche Situation hin, die zum Tod oder zu schweren Verletzungen führt, wenn sie nicht vermieden wird!

**▲ WARNUNG:** Weist auf eine gefährliche Situation hin, die zum Tod oder zu schweren Verletzungen führen kann, wenn sie nicht vermieden wird!

**▲ VORSICHT:** Weist auf eine gefährliche Situation hin, die zu leichten oder mittelschweren Verletzungen führen kann, wenn sie nicht vermieden wird!

**▲ HINWEIS:** Wichtige Informationen, jedoch nicht in Bezug auf Todes- oder Verletzungsgefahr (nur Sachschäden)!

### ALLGEMEINE HINWEISE

**▲ WARNUNG:** Die Montage und/oder Wartung dieses Produkts erfordert fortgeschrittene technische Fähigkeiten, geeignetes Werkzeug und ein gutes Verständnis der Werkzeugnutzung und Drehmomentangaben. Zu Ihrer eigenen Sicherheit empfiehlt SW-MOTECH, die Montage und/oder Wartung von einer qualifizierten und zertifizierten Zweiradwerkstatt durchführen zu lassen.

**▲ WARNUNG:** Wenn Sie sich für die Eigenmontage dieses Produkts entscheiden, lesen Sie vor Montage und Nutzung die Anbauanleitung sorgfältig und vollständig durch und befolgen Sie alle Anweisungen, um schwere oder tödliche Verletzungen zu vermeiden. Beachten Sie bei der Montage und Verwendung auch alle relevanten Informationen im Fahrzeughandbuch. **WENN SIE EINEN TEIL DIESER ANBAUANLEITUNG NICHT VERSTEHEN ODER EINE ERKLÄRUNG EINER ANWEISUNG BENÖTIGEN, VERSUCHEN SIE NICHT DIESES PRODUKT ZU MONTIEREN, OHNE SW-MOTECH UM HILFE ZU FRAGEN!**

**VORBEREITUNG:** Lesen Sie die Anbauanleitung aufmerksam und stellen Sie sicher, dass alle Teile der Stückliste vorhanden sind.

**▲ VORSICHT:** Achten Sie auf den sicheren Stand Ihres Fahrzeugs. Schalten Sie den Motor ab und ziehen Sie den Zündschlüssel. Lassen Sie den Motor/Auspuff bei Bedarf abkühlen. Klemmen Sie die Batterie bei Arbeiten an der Elektrik ab. Verwenden Sie nur geeignetes Werkzeug und tragen Sie während der Montage und Wartung immer eine Schutzbrille und Handschuhe. Lassen Sie sich bei der Montage und Wartung von einer zweiten Person helfen.

**MONTAGE:** Alle vom Fahrzeug entfernten Teile und Verbindungen müssen gemäß den Angaben des Fahrzeugherstellers wieder eingebaut oder durch von SW-MOTECH gelieferte Teile und Hardware ersetzt werden.

**▲ WARNUNG:** Sichern Sie alle Gewinde, sofern nicht anders angegeben, mit mittelstarker, flüssiger Schraubensicherung.

**▲ GEFAHR:** Von SW-MOTECH nicht definierte Anzugsdrehmomente müssen Sie vom Fahrzeughersteller oder von einer zertifizierten Motorradwerkstatt beziehen.

**FUNKTIONSKONTROLLE:** Stellen Sie nach der Montage sicher, dass keine beweglichen Teile blockiert sind und die Funktion des Fahrzeugs nicht gestört wird. Kabel und Schläuche dürfen nicht scheuern und/oder geklemmt werden.

**▲ WARNUNG:** Führen Sie vor Fahrtbeginn eine umfassende Funktionskontrolle durch. Prüfen Sie nach den ersten 50 km und dann regelmäßig das Anzugsmoment aller Verbindungen und den festen Sitz des Produkts. Montiertes Zubehör kann das Fahrverhalten und die Stabilität des Fahrzeugs verändern.



SW-MOTECH GmbH & Co. KG  
Ernteweg 7-10  
35282 Rauschenberg  
Deutschland



[info@sw-motech.com](mailto:info@sw-motech.com)  
[www.sw-motech.com](http://www.sw-motech.com)



Beachten Sie in dem Abschnitt MONTAGE vorkommenden Symbole und deren Bedeutung. Wenn im Abschnitt MONTAGE die Bezeichnung OEM vorkommt, müssten die Vorgaben des Fahrzeugherstellers beachtet und angewandt werden.



Bei Fragen steht Ihnen unser Kundendienst sowie unsere Distributoren gerne zur Verfügung. Unsere Telefonnummer sowie eine Liste unserer Distributoren finden Sie in unserem Webshop: [www.sw-motech.com](http://www.sw-motech.com)



**Schraubensicherung verwenden:** Weist darauf hin, dass ein Gewinde mit flüssiger Schraubensicherung bestrichen werden muss. H (HIGH): hohe Festigkeit; M (MEDIUM): mittlere Festigkeit; L (LOW): niedrige Festigkeit.



**Anziehen / Anzugsmomentangabe beachten:** Weist auf das von SW-MOTECH bzw. vom Fahrzeughersteller (OEM) vorgegebene Anzugsmoment eines Teils hin.



**Keine Schraubensicherung verwenden:** Weist darauf hin, dass an der Stelle keine flüssige Schraubensicherung notwendig ist.

STÜCKLISTE - ANBAUANLEITUNG LESEN UND AUFBEWAHREN!

1

1



HDG.00.220.907.01.25

 1/1

2



HDG.00.220.908.01.25

 1/1

3



HDG.00.220.039L.25

 1/1

4



HDG.00.220.039R.25

 1/1

5



M6 x 20; DIN 7380  
SC.ST.06.020.02.7380.109

 1/1

2

6



HDG.00.220.025L.25

 1/1

7



HDG.00.220.025R.25

 1/1

8



M10 x 55; DIN 6912  
SC.ST.10.055.02.6912.088

 2/2

9



HDG.00.220.010.25

 2/2

10



Ø 20 / ø 10,5 / h 9  
DB.00.200.105.009.01

 2/2

3

11



M6 x 22; DIN 7991  
SC.ST.06.022.48.7991.088

 2/2

12



ø 6,4; DIN 9021  
US.ST.064.02.9021

 2/2

13



M6; DIN 6927  
MU.ST.06.02.6927.08

 2/2

1

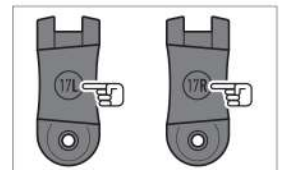
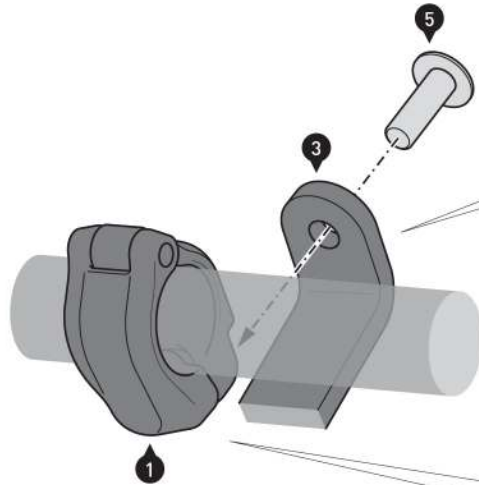

**⚠ WARNUNG:** Da das Handprotektoren Montage-Kit in einem sicherheitsrelevanten Bereich des Fahrzeugs verbaut wird, empfiehlt SW-MOTECH, die Montage/Wartung des Produkts von einer qualifizierten Fachwerkstatt durchführen zu lassen!

**⚠ WARNUNG:** Tragen Sie immer Augen- und Handschutz!  
**⚠ WARNUNG:** Verwenden Sie immer geeignetes Werkzeug!

**⚠ HINWEIS:** Die Montage ist linksseitig dargestellt. Wiederholen Sie die Montage mit den entsprechenden Teilen auf der rechten Lenkerseite.

**⚠ HINWEIS:** Der gezeigte Lenker dient als Beispiel.

**⚠ HINWEIS:** Das in der Zeichnung gezeigte Verbindungsblech (3) dient als Beispiel. Die korrekte Darstellung und Ausrichtung des Verbindungsblechs werden in der rechten Detailzeichnung gezeigt.

**⚠ HINWEIS:** Achten Sie auf die L/R-Markierungen der Schellen (1/2). Befestigen Sie die Schelle mit der L-Markierung auf der in Fahrtrichtung linken Lenkerseite; befestigen Sie die Schelle mit der R-Gravur auf der in Fahrtrichtung rechten Lenkerseite.

Legen Sie die Schellen (1/2) an den in der oberen Detailzeichnung gezeigten Stellen um den Lenker.

Verschrauben Sie die Verbindungsbleche (3/4) LOCKER mit den Schellen (1/2). Die Schellen (1/2) müssen zwecks Positionierung beweglich bleiben.

**⚠ WARNUNG:** Verwenden Sie flüssige Schraubensicherung!  
 Ziehen Sie die Schrauben (5) handfest an.



M 8 Nm

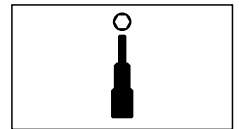
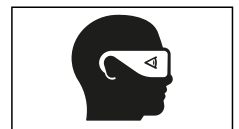

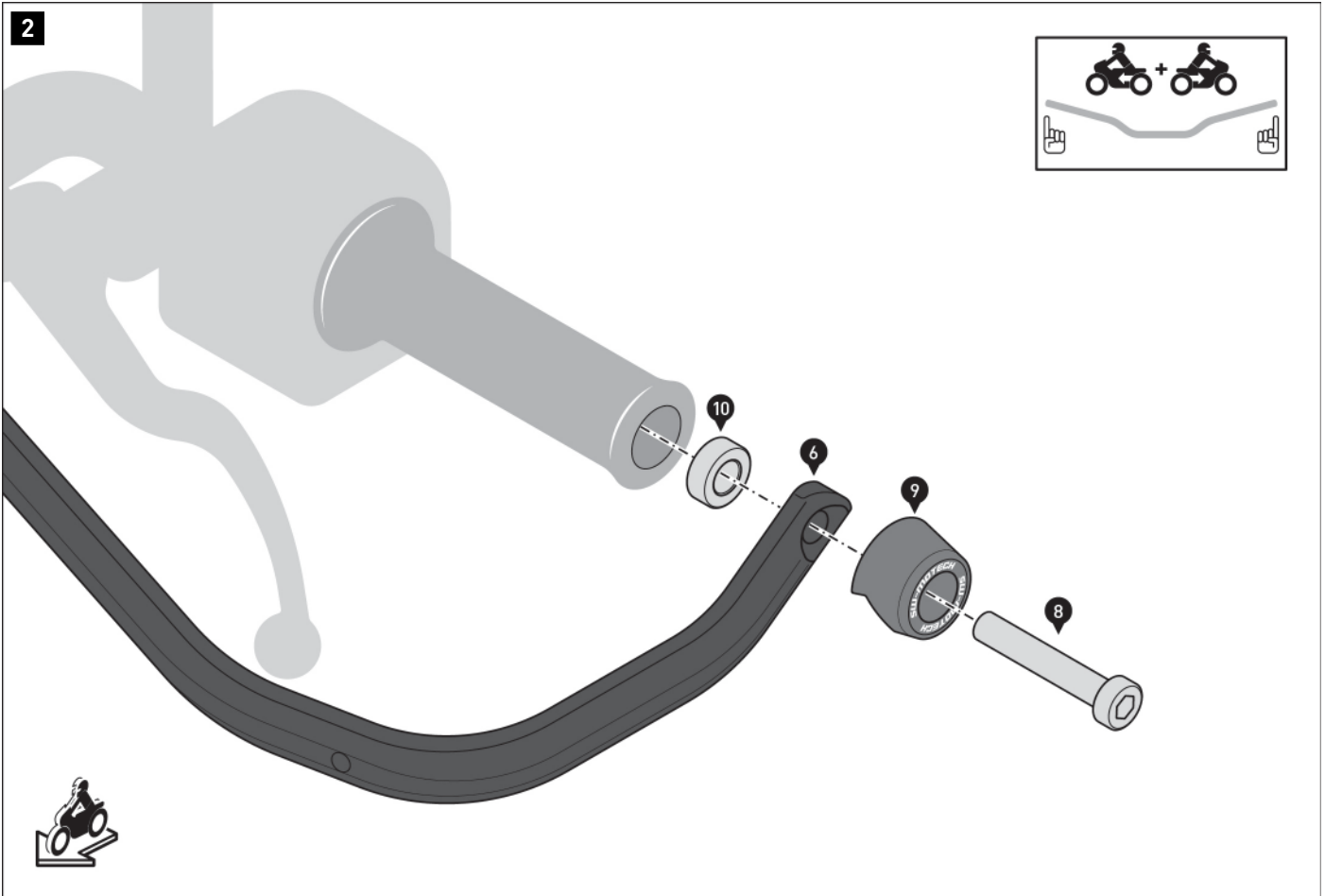

Demontieren Sie die original Endgewichte und Handprotektoren, falls montiert.  
Stellen Sie sicher, dass die Lenkerenden und das Innere des Lenkers frei sind.

Verschrauben Sie die gezeigten Teile locker mit den Bügeln (6/7) an den Lenkerenden.

**▲ WARNUNG: Verwenden Sie flüssige Schraubensicherung!**  
Ziehen Sie dazu die Schraube (8) so weit an, dass sich die Bügel (6/7) noch nachjustieren lassen.

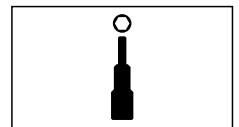
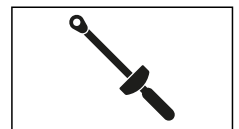

3

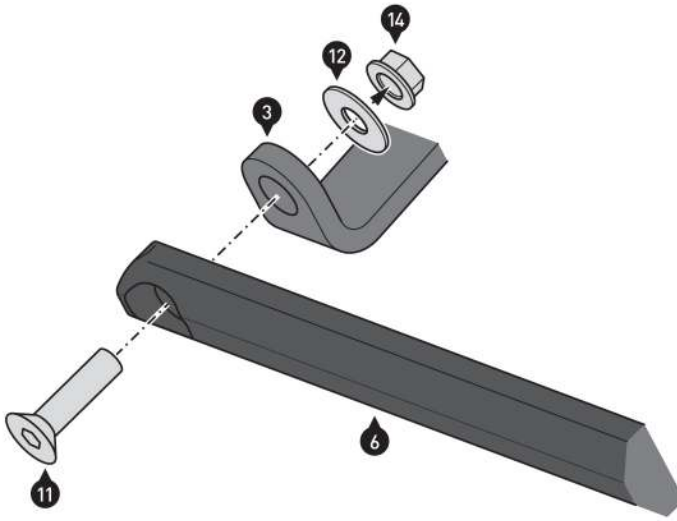

Verschrauben Sie die innenliegenden Enden der Bügel (6/7) mit den Verbindungsblechen (3/4).  
Ziehen Sie die Schrauben (11) noch nicht an.

Positionieren Sie nun die Bügel (6/7) Ihrer Fahrerergonomie entsprechend und ziehen Sie alle Schrauben in der folgenden Reihenfolge und wie in der Anbauanleitung vorgegeben an: (11), (5), (8).

**▲ GEFAHR:** Falls das Platzangebot nach Montage aller Komponenten zu knapp ist, muss die Brems- und Kupplungseinheit einige Millimeter in Richtung Lenkerende bzw. Lenkermitte versetzt werden!

**▲ GEFAHR:** Stellen Sie nach der Montage sicher, dass alle Schalter- und Kontrolleinheiten, besonders der Gasgriff, Bremshebel, Notausschalter und die Kupplung einwandfrei funktionieren und leicht zu bedienen sind! Stellen Sie des Weiteren sicher, dass der Lenker in beide Richtungen voll eingeschlagen werden kann. Sollten Teile des Produkts bei vollem Lenkeinschlag Kontakt mit dem Tank oder anderen Fahrzeugkomponenten haben, ist eine Neupositionierung des Produkts bzw. des Lenkers zwingend notwendig!

Achten Sie dabei auf die Übereinstimmung mit den Fahrzeughersteller-Vorgaben! Fahren Sie NICHT mit Ihrem Fahrzeug, wenn die Schalter- und Kontrolleinheiten nicht korrekt funktionieren oder zu bedienen sind! Führen Sie VOR jeder Fahrt eine vollständige Funktionskontrolle des Lenkers und aller Armaturen durch!



**PRODUKTSPEZIFISCHE HINWEISE**

**⚠ HINWEIS:** Beachten Sie die landesspezifischen Vorschriften für Zulassung/Betrieb Ihres Fahrzeugs bzw. anwendbare TÜV-Vorschriften. Lassen Sie eintragungspflichtige Teile nach Montage durch Ihre Prüfstelle in die Fahrzeugpapiere eintragen.



Item number: HDG.00.220.81801/B

Revision: 00 · Date: 01 - 2024

## Handguard mounting kit

 ~ 0.5 h.

 EASY     DIFFICULT

**ENGLISH** Thank you for choosing this premium product from SW-MOTECH. Visit our online shop for more information (e.g. model assignments). Required documents (e.g. national type approval) are available there for you to download.

Please read and understand all the instructions, safety information and warnings in these mounting instructions before mounting and using the product in order to avoid injury and damage. Keep these mounting instructions for reference.

This product was developed for vehicles in factory condition. Compatibility with original accessories or accessories from other manufacturers cannot be guaranteed.

These mounting instructions have been prepared to the best of our current knowledge. No legal claims relating to accuracy can be made. Errors and omissions excepted. We reserve the right to make technical and design changes. The copyright is held by SW-MOTECH.

### SAFETY WARNING SYMBOL

 This warning symbol is used in these mounting instructions to warn of deadly dangers, injuries or other hazards. The words **DANGER**, **WARNING** or **CAUTION** are used as part of this warning symbol to convey important safety messages and information relating to the installation and use of this product. These words, together with the safety warning symbol, mean:

 **DANGER:** Indicates a hazardous situation which, if not avoided, will result in death or serious injury!

 **WARNING:** Indicates a hazardous situation which, if not avoided, may result in death or serious injury!

 **CAUTION:** Indicates a hazardous situation which, if not avoided, may result in minor or moderate injury!

 **NOTE:** Important information, but not relating to a risk of death or injury (property damage only)!

### GENERAL INFORMATION

 **WARNING:** Assembly and/or maintenance of this product requires advanced technical skill, appropriate tools, and a good understanding of tool usage and torque specifications. For your own safety, SW-MOTECH recommends having the assembly and/or maintenance carried out by a qualified and certified motorcycle workshop.

 **WARNING:** If you do choose to assemble this product yourself, carefully and fully read the mounting instructions before assembly and use, and follow all instructions to avoid serious injury or death. Also observe all relevant information in the vehicle manual when mounting or using the product. IF YOU DO NOT UNDERSTAND ANY PART OF THESE MOUNTING INSTRUCTIONS OR NEED AN EXPLANATION AS TO A SPECIFIC INSTRUCTION, DO NOT ATTEMPT TO INSTALL THIS PRODUCT WITHOUT CONSULTING SW-MOTECH FOR ASSISTANCE!

**PREPARATION:** Read the mounting instructions carefully and make sure that all parts on the parts list are available.

 **CAUTION:** Ensure that your vehicle is standing securely. Switch off the engine and remove the ignition key. Allow the engine/exhaust to cool down if necessary. Disconnect the battery when working on the electrical system. Only use proper tools and always wear safety goggles and gloves during assembly and maintenance. Have a second person help you with assembly and maintenance.

**ASSEMBLY:** All parts and connections removed from the vehicle must be reinstalled according to the vehicle manufacturer's specifications or replaced with parts and hardware supplied by SW-MOTECH.

 **WARNING:** Secure all threads with a medium-strength liquid threadlocker, unless otherwise specified.

 **DANGER:** Tightening torques not defined by SW-MOTECH must be obtained from the vehicle manufacturer or a certified motorbike workshop.



**FUNCTIONAL CHECK:** After mounting the product, ensure that no moving parts are obstructed and that the function of the vehicle is not impeded. Cables and hoses must not rub against each other and/or be hindered in any way.

 **WARNING:** Carry out a comprehensive functionality check before you start to drive. Check the tightening torque of all connections and the tight fit of the product after the first 50 km and then at regular intervals. Mounted accessories can change the handling and stability of the vehicle.



SW-MOTECH GmbH & Co. KG  
Ernteweg 7-10  
35282 Rauschenberg  
Germany



 [info@sw-motech.com](mailto:info@sw-motech.com)  
 [www.sw-motech.com](http://www.sw-motech.com)



Take note of the symbols and what they mean in the ASSEMBLY section. If the term OEM appears in the ASSEMBLY section, the vehicle manufacturer's specifications must be observed and applied.



If you have any questions, please don't hesitate to contact our Customer Service team or our distributors. You can find our telephone number and a list of our distributors in our online shop:

[www.sw-motech.com](http://www.sw-motech.com)



**Use thread locker:** Indicates that a thread must be coated with liquid thread locker. H (HIGH): high strength; M (MEDIUM): medium strength; L (LOW): low strength.



**Tighten/note the tightening torque information:** Indicates the tightening torque of a part specified by SW-MOTECH or the vehicle manufacturer (OEM).



**Do not use thread lock:** Indicates that no liquid thread lock should be used at this point.

PARTS LIST - READ AND KEEP MOUNTING INSTRUCTIONS!

1

1



HDG.00.220.907.01.25

 1/1

2



HDG.00.220.908.01.25

 1/1

3



HDG.00.220.039L.25

 1/1

4



HDG.00.220.039R.25

 1/1

5



M6 x 20; DIN 7380  
SC.ST.06.020.02.7380.109

 1/1

2

6



HDG.00.220.025L.25

 1/1

7



HDG.00.220.025R.25

 1/1

8



M10 x 55; DIN 6912  
SC.ST.10.055.02.6912.088

 2/2

9



HDG.00.220.010.25

 2/2

10



Ø 20 / ø 10,5 / h 9  
DB.00.200.105.009.01

 2/2

3

11



M6 x 22; DIN 7991  
SC.ST.06.022.48.7991.088

 2/2

12



ø 6.4; DIN 9021  
US.ST.064.02.9021

 2/2

13



M6; DIN 6927  
MU.ST.06.02.6927.08

 2/2

1

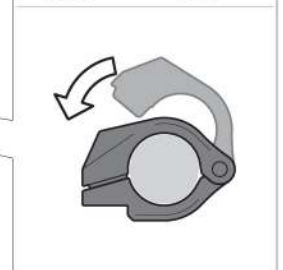
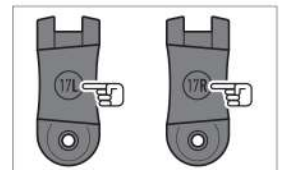
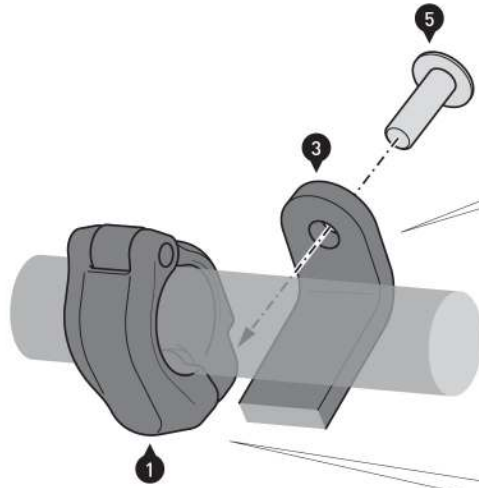

**⚠ WARNING:** Since the handguard mounting kit is installed in a safety-relevant area of the vehicle, SW-MOTECH recommends having the installation/maintenance of the product carried out by a qualified specialist workshop.

**⚠ WARNING:** Always wear eye and hand protection!  
**⚠ WARNING:** Always use the proper tools!

**⚠ NOTE:** Installation is shown on the left side. Repeat the installation with the corresponding parts on the right side of the handlebar.

**⚠ NOTE:** The handlebar shown serves as an example.

**⚠ NOTE:** The connecting plate (3) shown in the drawing serves as an example. The correct representation and orientation of the connecting plate are shown in the detailed drawing on the right.

**⚠ NOTE:** Pay attention to the L/R markings on the clamps (1/2). Attach the clamp with the L marking on the left side of the handlebar in the direction of travel; attach the clamp with the R engraving to the right side of the handlebar in the direction of travel.

Place the clamps (1/2) around the handlebars at the locations shown in the detailed drawing above.

LOOSELY screw the connecting plates (3/4) to the clamps (1/2). The clamps (1/2) must be able to be moved for positioning.

**⚠ WARNING:** Use a liquid threadlocker!  
 Tighten the screws (5) hand-tight.



M 8 Nm

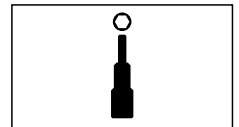
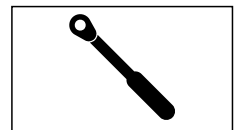
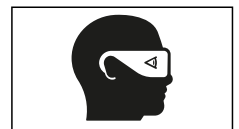

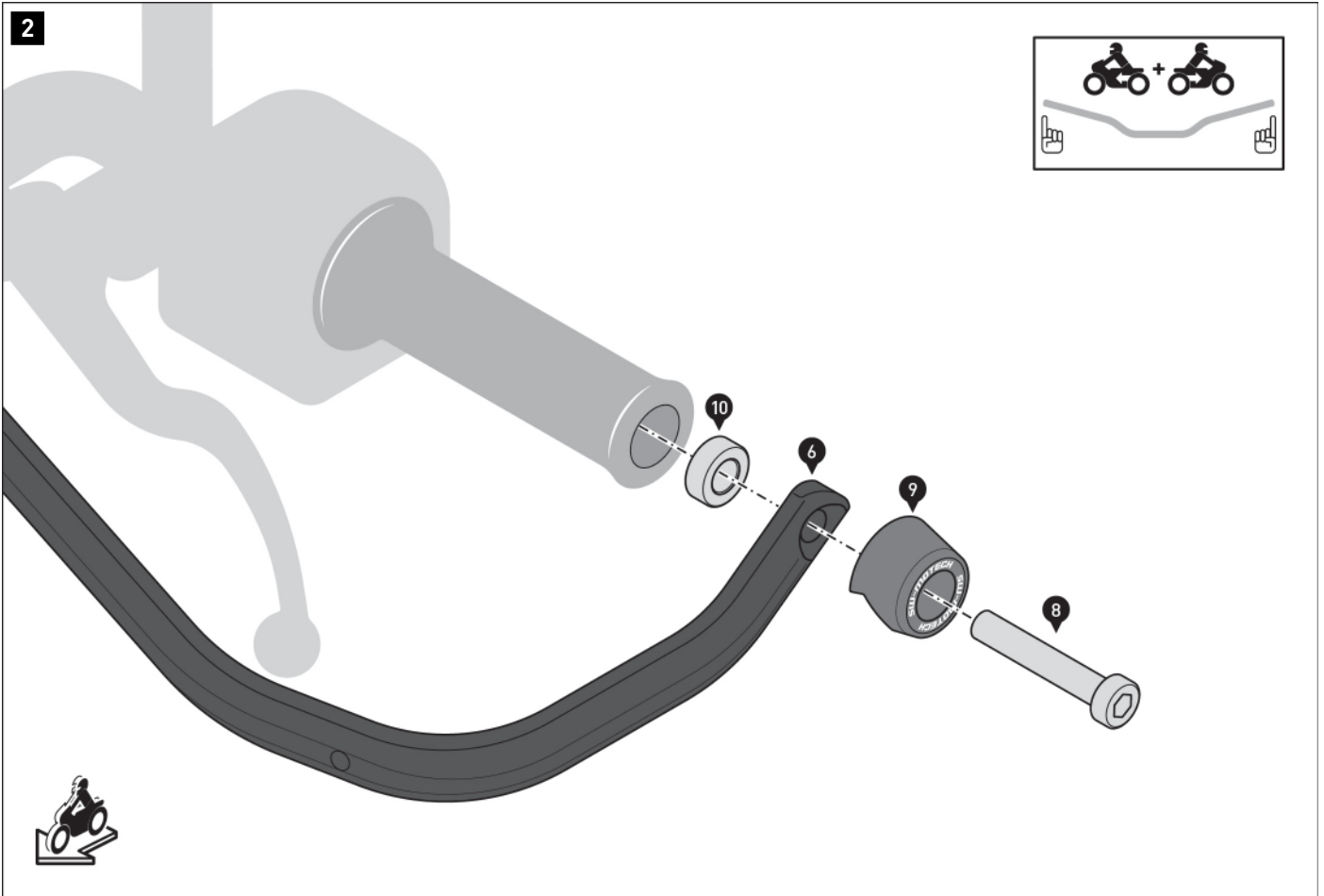

Remove the original end weights and handguards if mounted.  
Make sure the handlebar ends and the inside of the handlebars are clear.

Loosely screw the parts indicated to the brackets (6/7) on the handlebar ends.  
**▲ WARNING: Use a liquid threadlocker!**  
To do so, tighten the screw (8) so that the brackets (6/7) can still be readjusted.

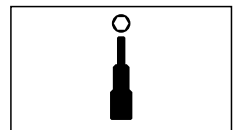
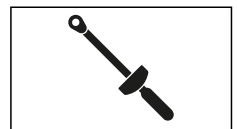

3

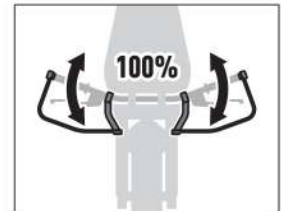
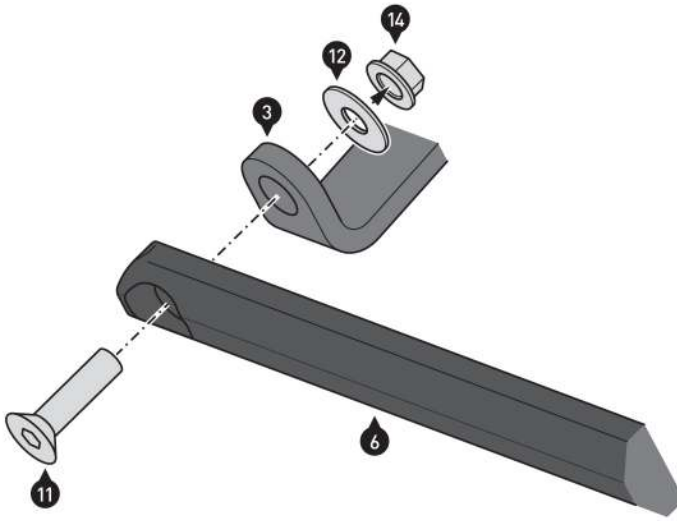

Screw the inner ends of the brackets (6/7) to the connecting plates (3/4). Do not tighten the screws (11) yet.

Now position the brackets (6/7) according to your personal preferences and tighten all screws in the following order and as specified in the mounting instructions: (11), (5), (8).

**⚠ DANGER:** If there is not enough space after installation of all components, the brake and clutch unit must be moved a few millimeters towards the end or middle of the handlebar!

**⚠ DANGER:** After installation, make sure that all switch and control units, especially the throttle assembly, brake lever, emergency stop switch and clutch, function properly and are easy to use! Also make sure that the handlebars can be fully turned in both directions. If parts of the product come into contact with the tank or other vehicle components when the steering wheel is at full lock, repositioning the product or the handlebars is absolutely necessary! Make sure that the installation complies with the vehicle manufacturer's specifications! DO NOT ride your vehicle if the switch and control units are not functioning correctly or cannot be operated correctly! BEFORE every ride, carry out a complete functional check of the handlebars and all fittings!

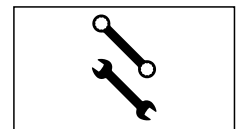
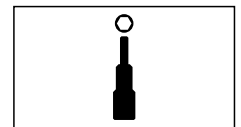
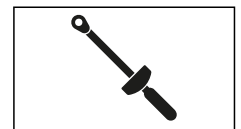

**PRODUCT-SPECIFIC NOTES**

**⚠ NOTE:** *Observe the country-specific regulations for the registration/operation of your vehicle or applicable TÜV regulations. After assembly, have parts that are subject to registration entered in the vehicle documents by your test centre.*

Número de artículo: HDG.00.220.81801/B

Revisión: 00 · Fecha: 01 - 2024

## Kit de montaje para protectores de manos

 ~ 0.5 h.

 FÁCIL     COMPLICADO

**ESPAÑOL** · Gracias por elegir este producto de primera calidad de SW-MOTECH. Visite nuestra tienda online para obtener más información (p. ej., sobre el uso de los modelos). Desde esa página podrá descargar los documentos que necesite (por ejemplo, la homologación nacional de tipo).

Para evitar lesiones y daños, asegúrese de leer y comprender todas las instrucciones, advertencias de seguridad y precauciones de este manual antes de montar y utilizar el producto. Guarde estas instrucciones de montaje como referencia.

Este producto ha sido desarrollado para vehículos en condiciones de fábrica. No se garantiza la compatibilidad con los accesorios originales o de otros fabricantes.

Estas instrucciones de montaje se han redactado de acuerdo con nuestros conocimientos actuales. No hay reclamaciones legales de corrección. Salvo errores y omisiones. Nos reservamos el derecho a realizar cambios técnicos y de diseño. Los derechos de autor pertenecen a SW-MOTECH.

### SÍMBOLO DE ADVERTENCIA DE SEGURIDAD

 Este símbolo de advertencia se utiliza en estas instrucciones de montaje para advertir de peligros mortales, lesiones u otros riesgos. Las palabras PELIGRO, ATENCIÓN o PRECAUCIÓN se utilizan con este símbolo de advertencia para transmitir importantes avisos de seguridad e información relacionada con el montaje y uso de este producto. Estas palabras, junto con el símbolo de advertencia de seguridad, significan:

 **PELIGRO:** Indica una situación de peligro que, si no se evita, provoca lesiones graves o incluso la muerte.

 **ATENCIÓN:** Indica una situación de peligro que, si no se evita, puede provocar lesiones graves o incluso la muerte.

 **PRECAUCIÓN:** Indica una situación de peligro que, si no se evita, puede provocar lesiones leves o de gravedad media.

 **NOTA:** Información importante, pero que no está relacionada con un riesgo de lesiones o muerte (solo daños materiales).

### INDICACIONES GENERALES

 **ATENCIÓN:** El montaje y/o mantenimiento de este producto requiere conocimientos técnicos avanzados, las herramientas apropiadas, un buen manejo de dichas herramientas y conocer las especificaciones de los pares de apriete. Por su propia seguridad, SW-MOTECH recomienda que el montaje y/o el mantenimiento los realice un taller de motocicletas cualificado y certificado.

 **ATENCIÓN:** Si elige ensamblar este producto usted mismo, antes de montarlo y usarlo, lea las instrucciones de montaje detenidamente y en su totalidad, y siga todas las indicaciones para evitar lesiones graves o mortales. Cuando monte y utilice el producto, tenga también en cuenta toda la información relevante que figure en el manual del vehículo. SI NO ENTIENDE ALGUNA PARTE DE ESTAS INSTRUCCIONES DE MONTAJE O NECESITA ALGUNA ACLARACIÓN, NO INTENTE INSTALAR ESTE PRODUCTO SIN CONSULTAR A SW-MOTECH PARA OBTENER AYUDA.

**PREPARACIÓN:** Lea atentamente las instrucciones de montaje y asegúrese de que todas las piezas de la lista de piezas están presentes.

 **PRECAUCIÓN:** Asegúrese de que su vehículo esté estacionado de manera segura. Apague el motor y retire la llave de encendido. Deje que el motor o el escape se enfrien si es necesario. Desconecte la batería cuando trabaje en el sistema eléctrico. Utilice únicamente las herramientas adecuadas y use siempre gafas de seguridad y guantes al realizar el montaje y las tareas de mantenimiento. Pida a otra persona que le ayude con el montaje y el mantenimiento.

**MONTAJE:** Todas las piezas y conexiones retiradas del vehículo deben ser reinstaladas de acuerdo con las especificaciones del fabricante del vehículo o sustituidas por piezas y herrajes suministrados por SW-MOTECH.

 **ATENCIÓN:** Asegure todas las roscas con fijador de roscas líquido de resistencia media, a menos que se especifique lo contrario.

 **PELIGRO:** Los pares de apriete no definidos por SW-MOTECH deben obtenerse del fabricante del vehículo o de un taller de motocicletas certificado.

**COMPROBACIÓN FUNCIONAL:** Después del montaje, asegúrese de que no haya piezas móviles bloqueadas y de que no se altere el funcionamiento del vehículo. Los cables y tubos no deben rozarse ni quedar pinzados.

 **ATENCIÓN:** Realice una comprobación exhaustiva del funcionamiento antes de iniciar la marcha. Tras los primeros 50 km y, después, con regularidad, compruebe el par de apriete de todas las conexiones y que el producto está firmemente sujeto. Los accesorios instalados pueden cambiar el comportamiento de conducción y la estabilidad del vehículo.



SW-MOTECH GmbH & Co. KG  
Ernteweg 7-10  
35282 Rauschenberg  
Alemania



✉ info@sw-motech.com  
🌐 www.sw-motech.com





Preste atención a los símbolos que figuran en la sección de MONTAJE y su significado. Cuando, en la sección de MONTAJE, aparecen las siglas OEM, se deberán seguir y aplicar las especificaciones del fabricante del vehículo.



Si tiene alguna pregunta, nuestro servicio de atención al cliente y nuestros distribuidores estarán encantados de prestarle ayuda. Encontrará nuestro número de teléfono y una lista de nuestros distribuidores en nuestra tienda online:

[www.sw-motech.com](http://www.sw-motech.com)



**Usar fijador de roscas:** Indica que una rosca debe recubrirse con fijador de roscas líquido. H (HIGH): resistencia alta; M (MEDIUM): resistencia media; L (LOW): resistencia baja.



**Respete la información del par de apriete:** Indica el par de apriete de una pieza especificada por SW-MOTECH o el fabricante del vehículo (OEM).



**No usar fijador de roscas:** Indica que no es necesario usar fijador de roscas líquido en este punto.

LISTA DE PIEZAS - LEE Y CONSERVA LAS INSTRUCCIONES DE MONTAJE!

1

1



HDG.00.220.907.01.25

 1/1

2



HDG.00.220.908.01.25

 1/1

3



HDG.00.220.039L.25

 1/1

4



HDG.00.220.039R.25

 1/1

5



M6 x 20; DIN 7380  
SC.ST.06.020.02.7380.109

 1/1

2

6



HDG.00.220.025L.25

 1/1

7



HDG.00.220.025R.25

 1/1

8



M10 x 55; DIN 6912  
SC.ST.10.055.02.6912.088

 2/2

9



HDG.00.220.010.25

 2/2

10



Ø 20 / ø 10,5 / h 9  
DB.00.200.105.009.01

 2/2

3

11



M6 x 22; DIN 7991  
SC.ST.06.022.48.7991.088

 2/2

12



ø 6,4; DIN 9021  
US.ST.064.02.9021

 2/2

13



M6; DIN 6927  
MU.ST.06.02.6927.08

 2/2

1

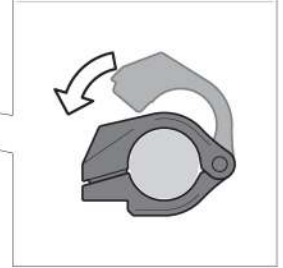
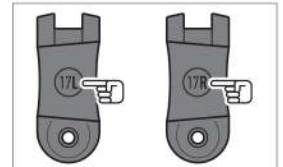
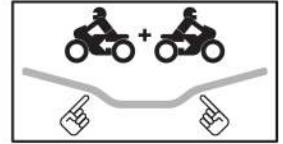
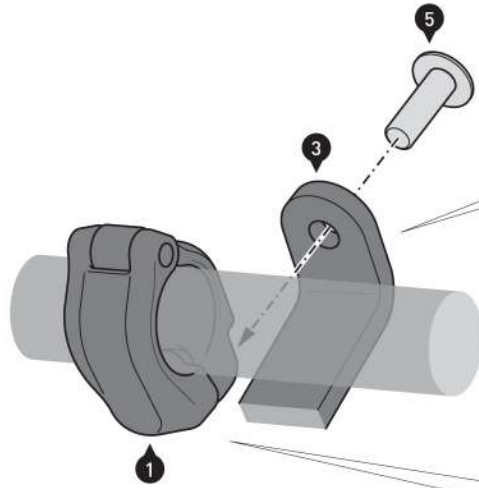

**⚠ ATENCIÓN:** El kit de fijación de los protectores de manos está instalado en una zona del vehículo relevante para la seguridad. Por lo tanto, SW-MOTECH recomienda que el montaje o el mantenimiento del producto lo lleve a cabo un taller especializado cualificado.

**⚠ ATENCIÓN:** ¡Use siempre protección de ojos y manos!  
**⚠ ATENCIÓN:** ¡Utilice siempre herramientas adecuadas!

**⚠ NOTA:** El montaje se muestra en el lado izquierdo. Repetir el montaje con las piezas correspondientes en el lado derecho del manillar.

**⚠ NOTA:** El manillar que se muestra es un ejemplo.

**⚠ NOTA:** La placa de conexión (3) que se muestra en el dibujo sirve como ejemplo. La representación y orientación correctas de la placa de conexión se muestran en el dibujo de detalle de la derecha.

**⚠ NOTA:** Preste atención a las marcas L/R de las abrazaderas (1/2). Fije la abrazadera con la marca L en el lado izquierdo del manillar en el sentido de la marcha y la abrazadera con la R en el lado derecho del manillar en el sentido de la marcha.

Coloque las abrazaderas (1/2) alrededor del manillar en los lugares que se indican en el dibujo de detalle de arriba.

Atornille sin apretar las placas de conexión (3/4) a las abrazaderas (1/2). Las abrazaderas (1/2) deben permanecer móviles para su posicionamiento.

**⚠ ATENCIÓN:** ¡Utilice fijador de roscas líquido!  
 Apriete a mano los tornillos (5).



M 8 Nm

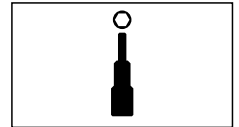
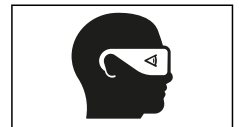

2

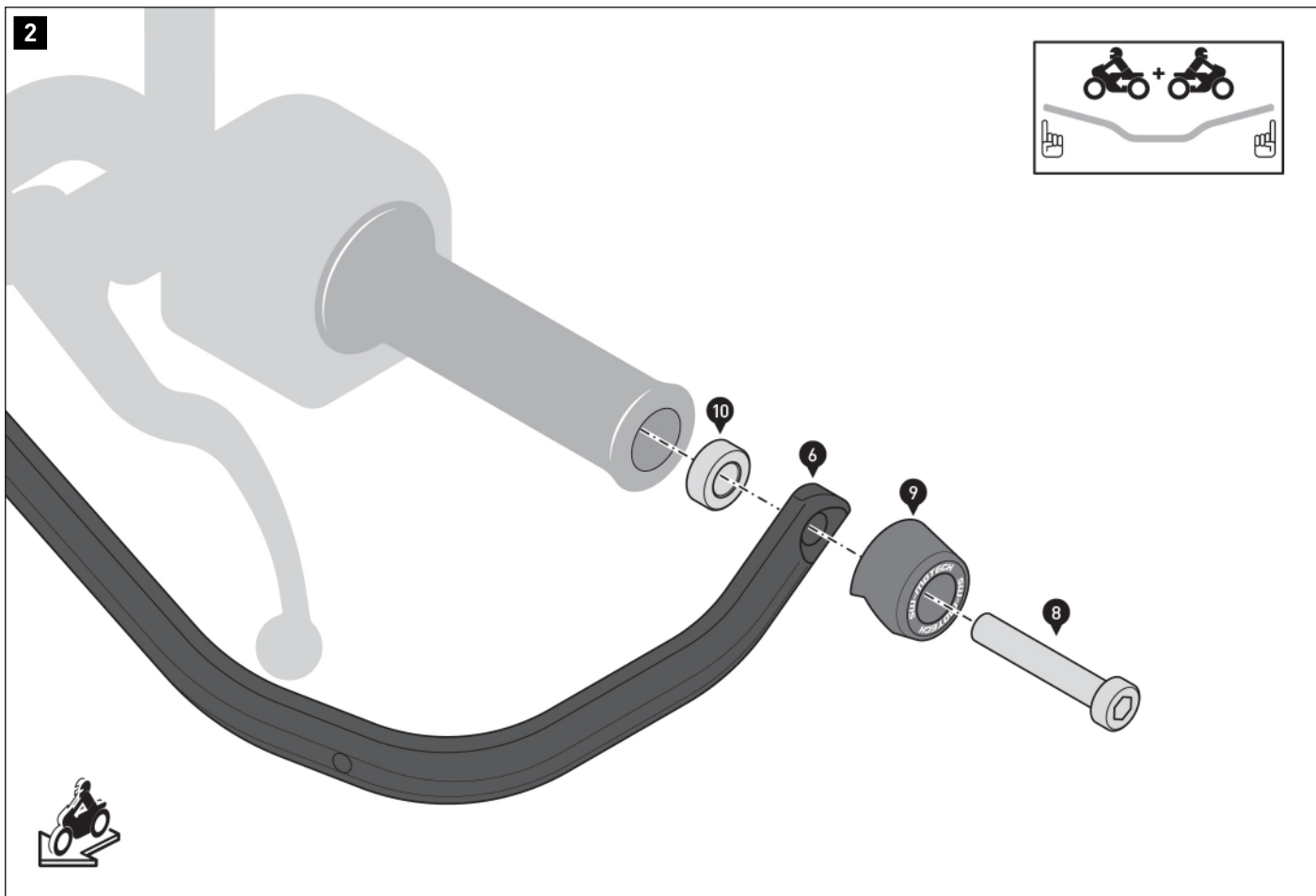

Retire los contrapesos finales originales y los protectores de manos, si los hubiera.  
Asegúrese de que los extremos y el interior del manillar estén despejados.

Atornille sin apretar las piezas indicadas a los soportes (6/7) en los extremos del manillar.

**▲ ATENCIÓN: ¡Utilice fijador de roscas líquido!**

Para ello, apriete el tornillo (8) lo suficiente para que aún se puedan reajustar los soportes (6/7).

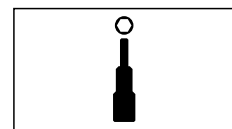
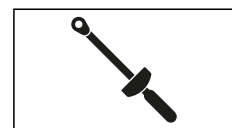

3

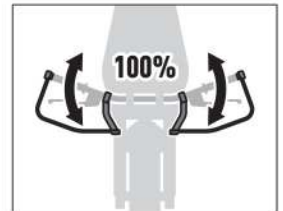
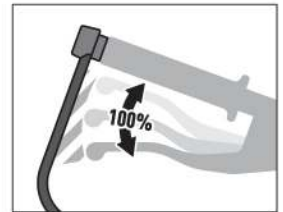
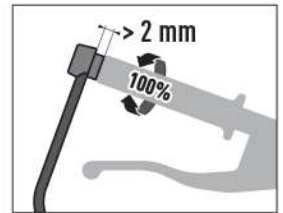
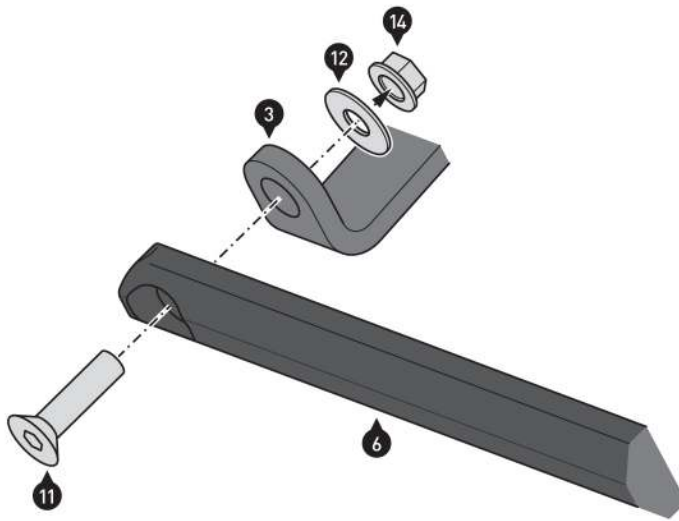

Atornille los extremos interiores de los soportes (6/7) a las placas de conexión (3/4). No apriete los tornillos (11) todavía.

Ahora coloque los soportes (6/7) según su ergonomía de conducción y apriete todos los tornillos en el siguiente orden según las instrucciones de montaje: (11), (5), (8).

**▲ PELIGRO: ¡Si no hay suficiente espacio después de ensamblar todos los componentes, el freno y el embrague deben moverse unos milímetros hacia el extremo o el centro del manillar!**

**▲ PELIGRO: Después del montaje, asegúrese de que todos los interruptores y controles, especialmente el puño acelerador, el pedal de freno, el interruptor de parada de emergencia y el embrague, funcionen correctamente y se puedan utilizar con facilidad.**

**Asegúrese también de que el manillar se pueda girar completamente en ambas direcciones. Si alguna pieza del producto entra en contacto con el tanque u otros componentes del vehículo cuando el volante está completamente girado, ¡es imprescindible reposicionar el producto o el manillar!**

**¡Asegúrese de cumplir con las especificaciones del fabricante del vehículo! ¡NO conduzca su vehículo si los interruptores y los controles no funcionan o no se pueden utilizar con normalidad!**

**ANTES de cada salida, ¡compruebe que el manillar y todos los accesorios funcionan correctamente!**

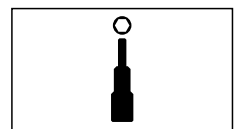
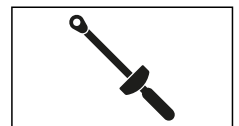

**INDICACIONES ESPECÍFICAS DEL PRODUCTO**

**⚠ NOTA:** *Tenga en cuenta las normas específicas del país para la matriculación/uso de su vehículo o las normas aplicables de la ITV. En caso de piezas con registro obligatorio, su organismo de inspección debe registrarlas tras el montaje en los documentos del vehículo.*

Numéro d'article: HDG.00.220.81801/B

Révision: 00 · Date: 01 - 2024

## Kit de montage des protège-mains

 ~ 0.5 h.

 FACILE    DIFFICILE

**FRANÇAIS** · Nous vous remercions d'avoir choisi ce produit haut de gamme de SW-MOTECH. Visitez notre boutique en ligne pour plus d'informations (par exemple affectation des modèles). Les documents nécessaires (par exemple ABE) y sont disponibles en téléchargement.

**Veillez lire et prendre en compte toutes les instructions, les consignes de sécurité et les avertissements contenus dans ce manuel de montage avant de monter et d'utiliser le produit afin d'éviter toute blessure ou tout dommage. Veuillez conserver la notice d'utilisation pour référence.**

**Ce produit a été développé pour des véhicules en configuration d'usine. Nous ne sommes pas en mesure d'assurer la compatibilité avec les pièces de rechange originales ou les pièces de rechange d'autres fabricants.**

**La présente notice d'installation a été élaborée conformément à nos connaissances actuelles. Il n'existe aucun droit juridique à l'exactitude des informations qu'elle contient. Sous réserve d'erreurs et de fautes. Sous réserve de modifications techniques et conceptuelles. SW-MOTECH détient les droits d'auteur.**

### SYMBOLE D'AVERTISSEMENT DE SÉCURITÉ

**⚠ Ce symbole d'avertissement est utilisé dans ces instructions de montage pour mettre en garde contre des dangers mortels, de blessures ou d'autres risques. Les mots DANGER, ATTENTION ou RECOMMANDATION sont utilisés avec ce symbole d'avertissement pour transmettre des consignes de sécurité et des informations importantes concernant le montage et l'utilisation de ce produit. Ces mots, associés au symbole d'avertissement de sécurité, signifient :**

**⚠ DANGER :** signale une situation dangereuse pouvant entraîner la mort ou des blessures graves si elle n'est pas évitée !

**⚠ ATTENTION :** signale une situation dangereuse pouvant entraîner la mort ou des blessures graves si elle n'est pas évitée !

**⚠ PRUDENCE :** Indique une situation dangereuse susceptible d'entraîner des blessures de gravité réduite ou moyenne si elle se présente !

**⚠ REMARQUE :** Informations importantes, mais qui n'entraînent pas de risque de décès ou de blessure (dommages matériels uniquement).

### REMARQUES GÉNÉRALES

**⚠ ATTENTION :** le montage et/ou l'entretien de ce produit nécessite des compétences techniques avancées, des outils appropriés et une bonne compréhension de l'utilisation des outils et des indications de réglage. Pour votre propre sécurité, SW-MOTECH recommande de confier le montage et/ou l'entretien à un atelier de réparation de deux-roues qualifié et certifié.

**⚠ ATTENTION :** si vous décidez de monter vous-même ce produit, lisez attentivement et intégralement les instructions de montage avant le montage et l'utilisation et suivez toutes les instructions afin d'éviter des blessures graves ou mortelles. Lors du montage et de l'utilisation, tenez également compte de toutes les informations pertinentes du manuel du véhicule. **SI VOUS NE COMPRENEZ PAS UNE PARTIE DE CE MANUEL D'INSTALLATION OU SI VOUS AVEZ BESOIN D'EXPLICATIONS CONCERNANT UNE INSTRUCTION, N'ESSAYEZ PAS D'INSTALLER CE PRODUIT SANS DEMANDER DE L'AIDE À SW-MOTECH !**

**PRÉPARATION :** Veuillez lire attentivement les instructions de montage et assurez-vous que tous les éléments de la liste de pièces sont présents.

**⚠ PRUDENCE :** veillez à ce que votre véhicule soit bien stable. Éteignez le moteur et retirez la clé de contact. Laissez refroidir le moteur/l'échappement si nécessaire. Débranchez la batterie lorsque vous travaillez sur le système électrique. Utilisez uniquement des outils appropriés et portez toujours des lunettes de protection et des gants pendant le montage et l'entretien. Faites-vous aider par une deuxième personne lors du montage et de l'entretien.

**MONTAGE :** Toutes les pièces et connexions retirées du véhicule doivent être réinstallées conformément aux instructions du fabricant du véhicule ou remplacées par des pièces et du matériel fournis par SW-MOTECH.

**⚠ ATTENTION** Sauf indication contraire, sécurisez tous les filetages avec du frein filet liquide de force moyenne.

**⚠ DANGER :** Les couples de serrage non définis par SW-MOTECH doivent être obtenus auprès du constructeur du véhicule ou d'un atelier de réparation de motos certifié.

**CONTRÔLE DU FONCTIONNEMENT :** Après le montage, assurez-vous qu'aucune pièce mobile n'est bloquée et que le fonctionnement du véhicule n'est pas perturbé. Les câbles et les tuyaux ne doivent pas frotter et/ou être coincés.

**⚠ ATTENTION :** Effectuez un contrôle de fonctionnement complet avant de commencer à rouler. Après les 50 premiers kilomètres, puis régulièrement, vérifiez le couple de serrage de tous les raccords et la bonne fixation du produit. Les accessoires montés peuvent modifier le comportement sur la route et la stabilité du véhicule.



SW-MOTECH GmbH & Co. KG  
Ernteweg 7-10  
35282 Rauschenberg  
Allemagne



✉ [info@sw-motech.com](mailto:info@sw-motech.com)  
🌐 [www.sw-motech.com](http://www.sw-motech.com)



Vous trouverez les symboles et leur signification dans la section MONTAGE. Si le terme OEM apparaît dans la section MONTAGE, il faut respecter et appliquer les consignes du fabricant du véhicule.



Si vous avez des questions, notre service clientèle ainsi que nos distributeurs se tiennent à votre disposition. Vous trouverez notre numéro de téléphone ainsi que la liste de nos distributeurs sur notre boutique en ligne : [www.sw-motech.com](http://www.sw-motech.com)



**Utilisez du frein filet :** Indique qu'un filetage doit être enduit de frein filet liquide. H (HIGH) : haute résistance ; M (MEDIUM) : force moyenne ; L (LOW) : faible résistance.



**Serrer en respectant les instructions de couple de serrage :** indique le couple de serrage d'une pièce prescrit par SW-MOTECH ou par le fabricant du véhicule (OEM).



**Ne pas utiliser de frein filet :** signifie que l'utilisation d'un frein filet liquide n'est pas nécessaire à ce stade.



LISTE DES PIÈCES - LIRE ET CONSERVER LES INSTRUCTIONS DE MONTAGE!

1

1



HDG.00.220.907.01.25

 1/1

2



HDG.00.220.908.01.25

 1/1

3



HDG.00.220.039L.25

 1/1

4



HDG.00.220.039R.25

 1/1

5



M6 x 20; DIN 7380  
SC.ST.06.020.02.7380.109

 1/1

2

6



HDG.00.220.025L.25

 1/1

7



HDG.00.220.025R.25

 1/1

8



M10 x 55; DIN 6912  
SC.ST.10.055.02.6912.088

 2/2

9



HDG.00.220.010.25

 2/2

10



Ø 20 / ø 10,5 / h 9  
DB.00.200.105.009.01

 2/2

3

11



M6 x 22; DIN 7991  
SC.ST.06.022.48.7991.088

 2/2

12



ø 6,4; DIN 9021  
US.ST.064.02.9021

 2/2

13



M6; DIN 6927  
MU.ST.06.02.6927.08

 2/2

1

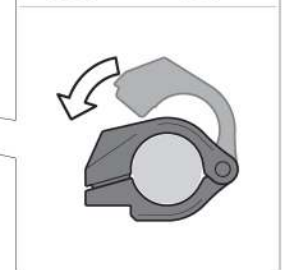
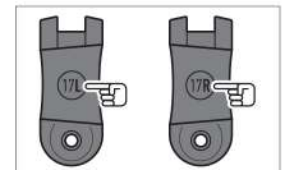
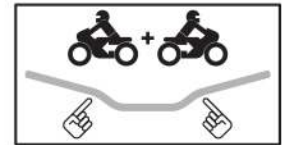
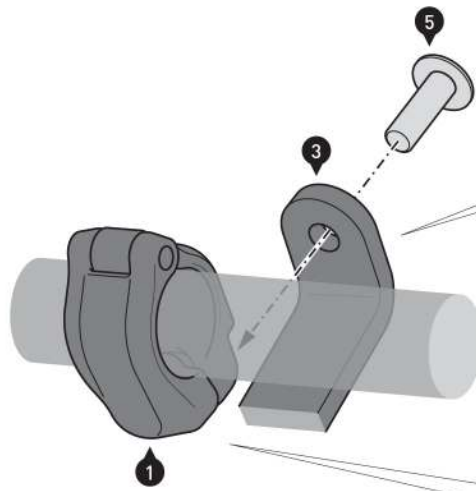

**⚠ ATTENTION** : étant donné que le kit de montage pour protège-mains s'installe dans une zone du véhicule essentielle pour la sécurité, SW-MOTECH recommande de confier le montage/l'entretien du produit à un atelier professionnel qualifié !

**⚠ ATTENTION** : portez toujours des lunettes et des gants de protection !  
**⚠ ATTENTION** : Utilisez toujours des outils appropriés !

**⚠ REMARQUE** : le montage est présenté du côté gauche. Répétez le montage avec les pièces correspondantes sur le côté droit du guidon.

**⚠ REMARQUE** : le guidon représenté est un exemple.

**⚠ REMARQUE** : la pièce de raccord [3] représentée sur le schéma est donnée à titre d'exemple. La représentation et l'orientation correctes de la pièce de raccord sont indiquées sur le schéma détaillé de droite.

**⚠ REMARQUE** : faites attention aux marquages L/R sur les colliers (1/2). Fixez le collier avec le marquage L sur le côté gauche du guidon dans le sens de la marche. Fixez le collier avec la marque R sur le côté droit du guidon dans le sens de la marche.

Placez les colliers de serrage (1/2) autour du guidon aux emplacements indiqués sur le schéma détaillé ci-dessus.

Vissez les pièces de raccord (3/4) SANS SERRER aux colliers (1/2). Les colliers (1/2) doivent rester mobiles afin de pouvoir être positionnés.

**⚠ ATTENTION** : utilisez du frein filet liquide !  
 Serrez les vis [5] à la main.



M 8 Nm

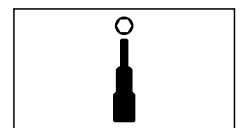
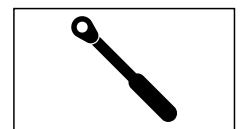
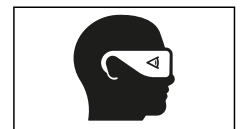

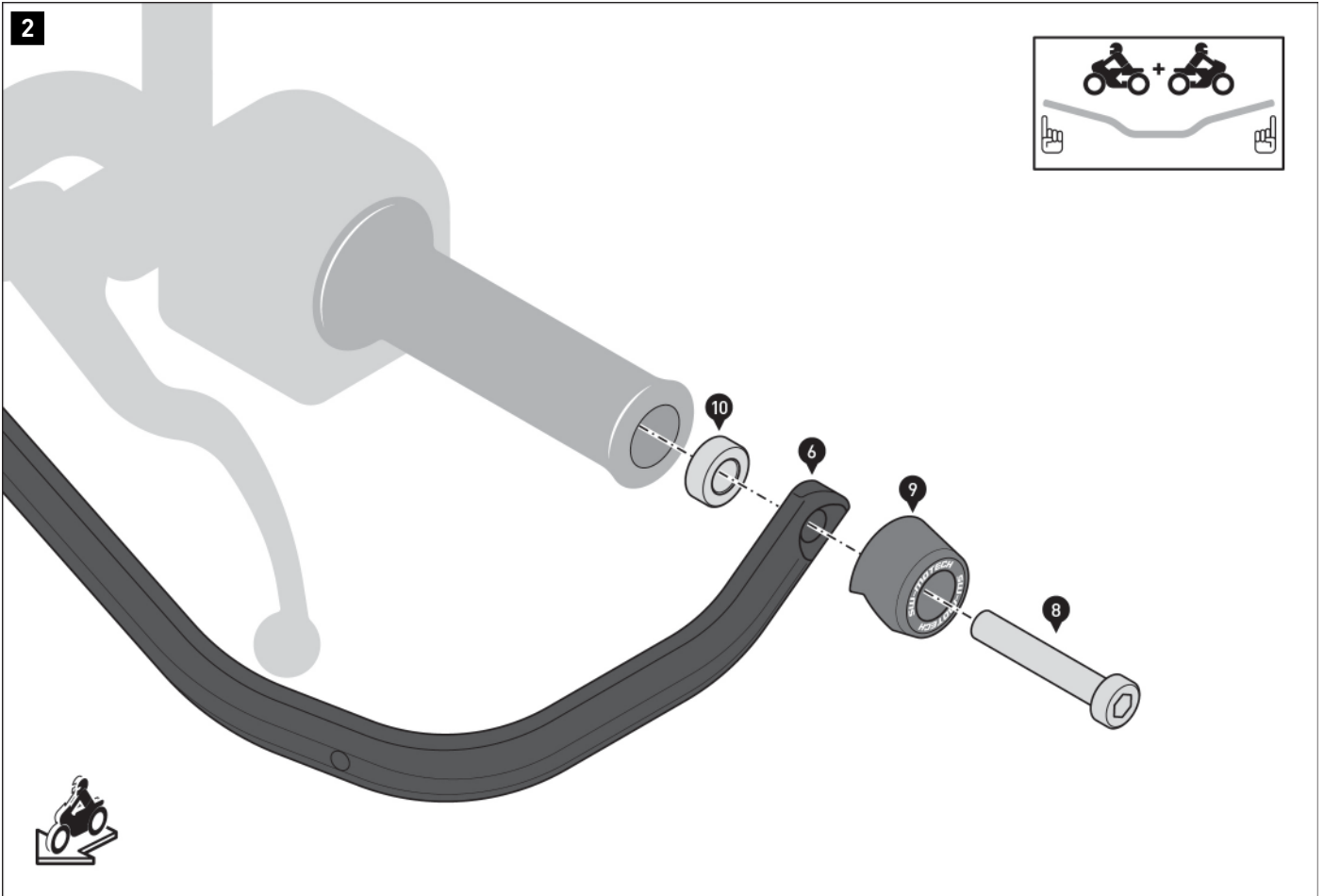

Démontez les masses d'extrémité et les protège-mains d'origine, s'ils sont en place. Assurez-vous que les extrémités du guidon et l'intérieur du guidon sont libres.

Vissez sans serrer les pièces indiquées aux supports (6/7) aux extrémités du guidon.

**⚠ ATTENTION : utilisez du frein filet liquide !**

Pour cela, serrez suffisamment la vis (8) pour que les supports (6/7) puissent encore être réajustés.

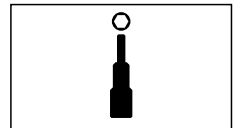
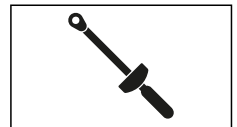

3

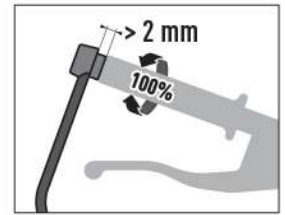
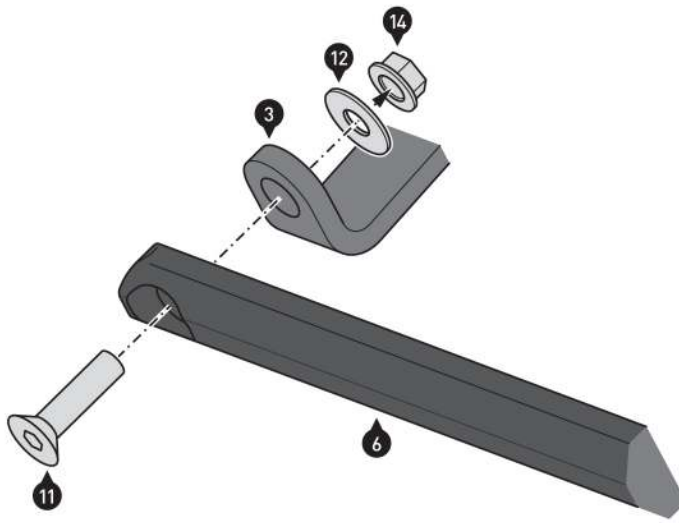

Vissez les extrémités intérieures des supports (6/7) aux plaques de connexion (3/4).  
Ne serrez pas encore les vis (11).

Positionnez maintenant les supports (6/7) selon votre ergonomie de conduite et serrez toutes les vis dans l'ordre suivant et comme indiqué dans les instructions de montage : (11), (5), (8).

**▲ DANGER** : si l'espace disponible après le montage de tous les composants est trop restreint, l'unité de freinage et d'embrayage doit être déplacée de quelques millimètres vers l'extrémité ou le centre du guidon !

**▲ DANGER** : après le montage, assurez-vous que tous les interrupteurs et commandes, en particulier la poignée d'accélérateur, le levier de frein, l'interrupteur d'arrêt d'urgence et l'embrayage, fonctionnent correctement et sans entrave !

Assurez-vous également que le guidon peut être braqué au maximum dans les deux sens. Si des parties du produit entrent en contact avec le réservoir ou d'autres composants du véhicule lorsque le guidon est complètement braqué, il est impératif de repositionner le produit ou le guidon !

Assurez-vous de respecter les spécifications du constructeur du véhicule !  
**NE roulez PAS** avec votre véhicule si les interrupteurs et les commandes ne fonctionnent pas correctement ou ne peuvent pas être actionnés correctement !

**AVANT** chaque utilisation, effectuez un contrôle complet du fonctionnement du guidon et de toutes les commandes !

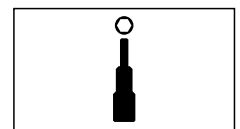
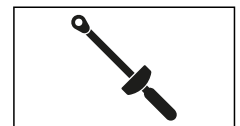

**REMARQUES SPÉCIFIQUES AU PRODUIT**

**⚠ REMARQUE** : Respectez les réglementations spécifiques au pays pour l'immatriculation/l'exploitation de votre véhicule ou les réglementations TÜV applicables. Après le montage, faites inscrire les pièces soumises à immatriculation dans les papiers du véhicule par votre centre de contrôle.

Numero di articolo: HDG.00.220.81801/B

Revisione: 00 · Data: 01 - 2024

## Kit di montaggio paramani

 ~ 0.5 h.FACILE     DIFFICILE

**ITALIANO** -Grazie per aver scelto questo prodotto premium di SW-MOTECH. Visita il nostro negozio online per ulteriori informazioni (ad es. per la compatibilità con i vari modelli). I documenti richiesti (ad es. certificato di omologazione nazionale) possono essere scaricati qui.

**Si prega di leggere attentamente le avvertenze di sicurezza e le istruzioni per il montaggio prima di montare e utilizzare il prodotto, al fine di evitare eventuali lesioni e danni. Conserva queste istruzioni per il montaggio come riferimento futuro.**

**Questo prodotto è stato sviluppato per veicoli in condizioni di fabbrica. La compatibilità con gli accessori originali o di altri produttori non può essere garantita.**

**Queste istruzioni per il montaggio sono state redatte in base alle nostre conoscenze attuali. Non sussistono pretese di correttezza giuridiche. Salvo errori ed omissioni. Ci riserviamo il diritto di apportare modifiche tecniche e di design. Copyright SW-MOTECH.**

## SIMBOLO DI SICUREZZA

 Questo simbolo di avvertenza è usato nelle presenti istruzioni di montaggio per segnalare pericoli mortali, rischio di lesioni o altri pericoli. Le parole "PERICOLO", "AVVERTENZA" O "ATTENZIONE" sono utilizzate con questo simbolo di avvertenza per trasmettere importanti istruzioni di sicurezza e informazioni relative al montaggio e all'uso di questo prodotto. Queste parole, utilizzate insieme al simbolo di avvertenza, significano:

 **PERICOLO:** indica una situazione di pericolo che, se non evitata, può causare morte o lesioni gravi!

 **AVVERTENZA:** indica una situazione di pericolo che, se non evitata, può causare morte o lesioni gravi!

 **ATTENZIONE:** indica una situazione di pericolo che, se non evitata, può provocare lesioni lievi o di entità moderata!

 **AVVISO:** indica informazioni importanti che non riguardano il rischio di morte o di lesioni (riguardano unicamente il rischio di danni materiali)!

## INFORMAZIONI GENERALI

 **AVVERTENZA:** il montaggio e/o la manutenzione di questo prodotto richiedono competenze tecniche avanzate, strumenti adeguati e una buona conoscenza dell'uso della strumentazione e delle indicazioni relative alle coppie di serraggio. Per ragioni di sicurezza, SW-MOTECH raccomanda di far eseguire il montaggio e/o la manutenzione presso un'officina per motociclette qualificata e certificata.

 **AVVERTENZA:** se si decide di installare questo prodotto in autonomia, leggere attentamente le istruzioni per il montaggio prima del montaggio e dell'uso e seguire tutte le avvertenze per evitare lesioni gravi o mortali. Durante il montaggio e l'uso, seguire anche tutte le istruzioni pertinenti contenute nel manuale del veicolo. **SE NON SI COMPRENDONO TALI ISTRUZIONI, ANCHE SOLO IN PARTE, O SE SONO NECESSARI CHIARIMENTI, NON CERCARE DI MONTARE IL PRODOTTO IN AUTONOMIA SENZA CHIEDERE IL SUPPORTO DI SW-MOTECH!**

**PREPARAZIONE:** leggere attentamente le istruzioni per il montaggio e assicurarsi che siano disponibili tutti i componenti contenuti nella lista.

 **ATTENZIONE:** assicurarsi che il veicolo sia perfettamente fermo. Spegner il motore e togliere la chiave. Se necessario, lasciar raffreddare il motore/lo scarico. Scollegare la batteria quando si interviene sull'impianto elettrico. Usare esclusivamente strumenti idonei e indossare sempre occhiali e guanti protettivi durante le operazioni di montaggio e manutenzione. Chiedere aiuto a una seconda persona durante le fasi di montaggio e manutenzione.

**MONTAGGIO:** tutti i componenti e i collegamenti rimossi dal veicolo devono essere reinstallati secondo le specifiche del produttore del veicolo o sostituiti con componenti e attrezzatura forniti da SW-MOTECH.

 **AVVERTENZA:** fissare tutte le filettature con frenafili liquido a media resistenza, se non diversamente specificato.

 **PERICOLO:** le coppie di serraggio non definite da SW-MOTECH devono essere richieste al costruttore del veicolo o a un'officina certificata.

**CONTROLLO DI FUNZIONALITÀ:** dopo il montaggio accertarsi che non vi siano parti mobili bloccate e che il funzionamento del veicolo non sia compromesso. I cavi e i tubi flessibili non devono sfregare e/o essere schiacciati.

 **AVVERTENZA:** eseguire un controllo completo delle funzioni prima di mettersi alla guida. Controllare la coppia di serraggio di tutti i collegamenti e la tenuta del prodotto dopo i primi 50 km e in seguito regolarmente. Gli accessori montati possono modificare la maneggevolezza e la stabilità del veicolo.



SW-MOTECH GmbH & Co. KG  
Ernteweg 7-10  
35282 Rauschenberg  
Germania



info@sw-motech.com  
www.sw-motech.com



Consultare i simboli e il loro significato nella sezione MONTAGGIO. Se nella sezione montaggio compare la sigla OEM, è necessario rispettare e applicare le specifiche del produttore del veicolo.



Per qualsiasi domanda, non esitare a contattare il nostro servizio clienti o i nostri distributori. Il nostro numero di telefono e l'elenco dei nostri distributori sono disponibili nel nostro negozio online:

**[www.sw-motech.com](http://www.sw-motech.com)**



**Usare un frenafiletto:** indica che la filettatura deve essere rivestita con un frenafiletto liquido. H (ALTA): alta resistenza; M (MEDIA): media resistenza; L (BASSO): bassa resistenza.



















**Serraggio / rispetto delle specifiche sulla coppia di serraggio:** indica la coppia di serraggio di un componente specificata da SW-MOTECH o dal produttore del veicolo (OEM).



**Non utilizzare il frenafiletto:** segnala di non dover utilizzare il frenafiletto liquido in quel determinato punto.

ELENCO DELLE PARTI - LEGGI E CONSERVA LE ISTRUZIONI DI MONTAGGIO!

<p><b>1</b></p>	<p><b>1</b></p>  <p>HDG.00.220.907.01.25</p> <p> 1/1</p>	<p><b>2</b></p>  <p>HDG.00.220.908.01.25</p> <p> 1/1</p>	<p><b>3</b></p>  <p>HDG.00.220.039L.25</p> <p> 1/1</p>	<p><b>4</b></p>  <p>HDG.00.220.039R.25</p> <p> 1/1</p>	<p><b>5</b></p>  <p>M6 x 20; DIN 7380 SC.ST.06.020.02.7380.109</p> <p> 1/1</p>
<p><b>2</b></p>	<p><b>6</b></p>  <p>HDG.00.220.025L.25</p> <p> 1/1</p>	<p><b>7</b></p>  <p>HDG.00.220.025R.25</p> <p> 1/1</p>	<p><b>8</b></p>  <p>M10 x 55; DIN 6912 SC.ST.10.055.02.6912.088</p> <p> 2/2</p>	<p><b>9</b></p>  <p>HDG.00.220.010.25</p> <p> 2/2</p>	<p><b>10</b></p>  <p>Ø 20 / ø 10,5 / h 9 DB.00.200.105.009.01</p> <p> 2/2</p>
<p><b>3</b></p>	<p><b>11</b></p>  <p>M6 x 22; DIN 7991 SC.ST.06.022.48.7991.088</p> <p> 2/2</p>	<p><b>12</b></p>  <p>ø 6,4; DIN 9021 US.ST.064.02.9021</p> <p> 2/2</p>	<p><b>13</b></p>  <p>M6; DIN 6927 MU.ST.06.02.6927.08</p> <p> 2/2</p>		



1

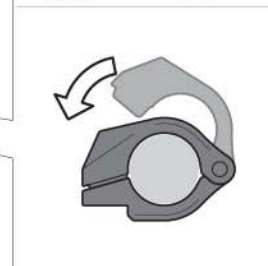
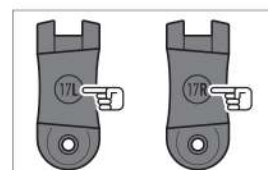
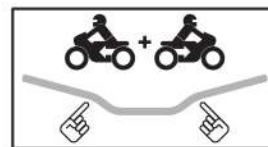
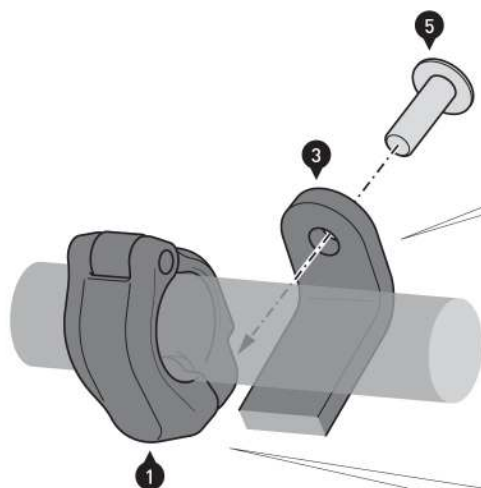

**⚠ AVVERTENZA:** poiché il kit di montaggio paramani viene installato in una zona del veicolo rilevante per la sicurezza, SW-MOTECH raccomanda che il montaggio e la manutenzione del prodotto vengano effettuati da un'officina specializzata qualificata!

**⚠ AVVERTENZA:** indossare sempre le protezioni per gli occhi e per le mani!  
**⚠ AVVERTENZA:** Utilizzare sempre strumenti adeguati!

**⚠ AVVISO:** l'illustrazione mostra il montaggio sul lato sinistro. Ripetere gli stessi passaggi utilizzando i componenti corrispondenti per effettuare il montaggio sul lato destro del manubrio.

**⚠ NOTA:** il manubrio mostrato nell'illustrazione funge da esempio.

**⚠ AVVISO:** la piastra di giunzione (3) mostrata nell'illustrazione funge da esempio. La rappresentazione e l'allineamento corretti della piastra di giunzione sono riportati in dettaglio nell'illustrazione a destra.

**⚠ AVVISO:** prestare attenzione alle marcature L/R sui morsetti (1/2). Fissare il morsetto con la marcatura L sul lato sinistro del manubrio in direzione di marcia; dopodiché fissare il morsetto con la marcatura R sul lato destro del manubrio in direzione di marcia.

Posizionare i morsetti (1/2) attorno al manubrio in corrispondenza dei punti mostrati in dettaglio nell'illustrazione soprastante.

Avvitare le piastre di giunzione (3/4) con i morsetti (1/2) SENZA SERRARE. I morsetti (1/2) devono rimanere mobili per agevolare il posizionamento.

**⚠ AVVERTENZA:** Usare un frenafiletti liquido!  
 Stringere manualmente le viti (5).

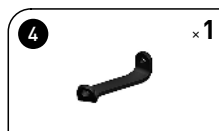

M 8 Nm

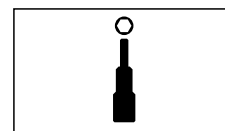
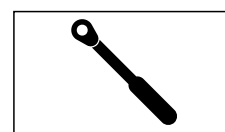
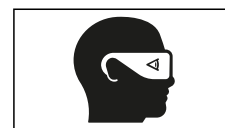

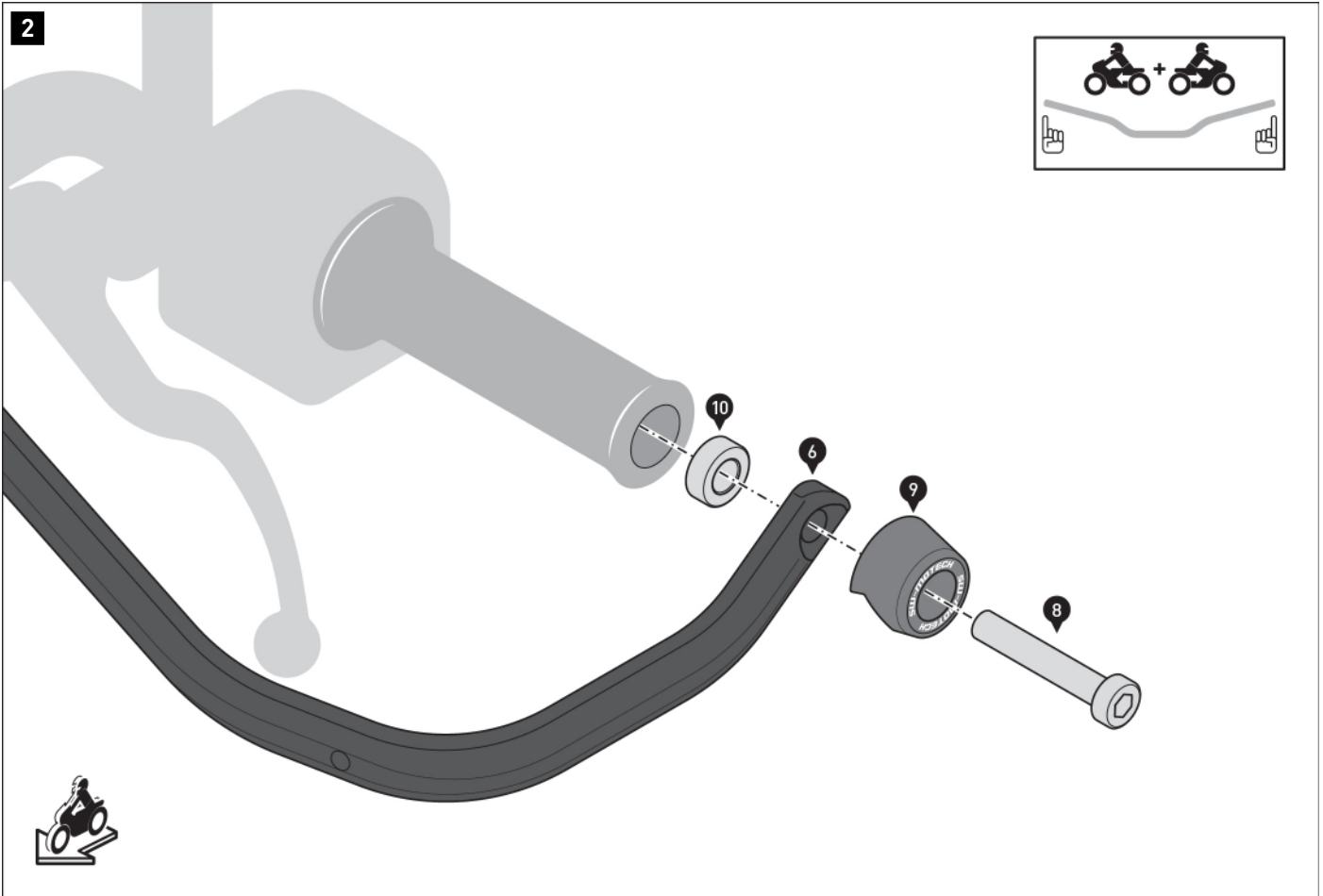

Rimuovere i contrappesi e i paramani originali, qualora fossero già montati. Assicurarsi che le estremità e l'interno del manubrio siano liberi.

Avvitare le parti mostrate alle staffe (6/7) senza serrare, come mostrato nell'illustrazione soprastante.

**⚠ AVVERTENZA: Usare un frenaflessi liquido!**

A tale scopo serrare la vite (8) quanto basta per poter ancora regolare le staffe (6/7).

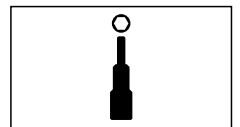
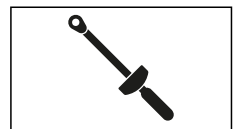

3

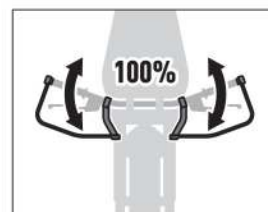
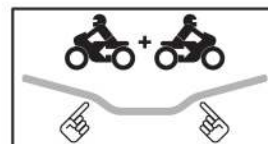
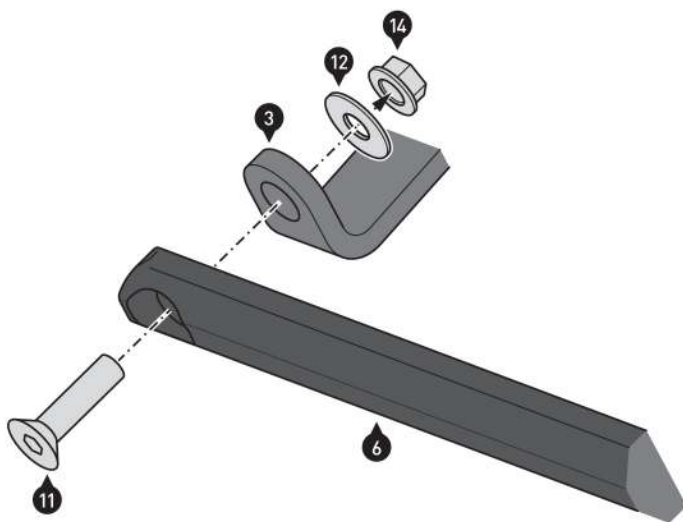

Avvitare le estremità interne delle staffe (6/7) alle piastre di giunzione (3/4). Non serrare ancora le viti (11).

Posizionare ora le staffe (6/7) in base alla propria ergonomia di guida e serrare tutte le viti nel seguente ordine e come specificato nelle istruzioni per il montaggio: (11), (5), (8).

**▲ PERICOLO:** se dopo aver montato tutti i componenti non c'è abbastanza spazio, sarà necessario spostare il gruppo freno e frizione di qualche millimetro verso l'estremità o il centro del manubrio!

**▲ PERICOLO:** dopo aver completato il montaggio, assicurarsi che tutte le unità di commutazione e di controllo, in particolare la manopola dell'acceleratore, la leva freno, l'interruttore di arresto di emergenza e la frizione, funzionino correttamente e siano facili da azionare! Assicurarsi inoltre che il manubrio possa essere completamente ruotato in entrambe le direzioni. Se alcune parti del prodotto entrano in contatto con il serbatoio o altri componenti del veicolo quando il manubrio è completamente girato, sarà assolutamente necessario riposizionare il prodotto o il manubrio!

Assicurarsi di rispettare le indicazioni fornite dal produttore del veicolo! **NON** mettersi alla guida del veicolo se le unità di commutazione e di controllo non funzionano correttamente o non possono essere azionate! **PRIMA** di mettersi alla guida, assicurarsi ogni volta che il manubrio e tutti gli strumenti di controllo funzionino correttamente!

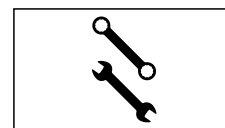
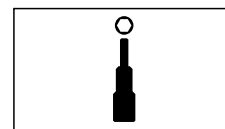
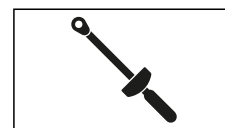
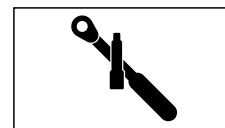

**AVVERTENZE SPECIFICHE DEL PRODOTTO**

**⚠ AVVISO** :Rispettare le normative specifiche del paese per l'immatricolazione/l'uso del veicolo o le normative TÜV applicabili. Dopo il montaggio, far inserire le parti soggette a omologazione nei documenti del veicolo dal proprio centro di test.

Art.-Nr.: HDG.00.220.10000/B

Revision: 01 · Datum: 12 - 2023

## Adventure Handprotector-Schalen-Set

 ~ 0.25 h.LEICHT     SCHWER

**DEUTSCH** - Vielen Dank, dass Sie sich für dieses Premium-Produkt von SW-MOTECH entschieden haben. Besuchen Sie unseren Webshop für weitere Informationen (z. B. Modellzuweisungen). Erforderliche Dokumente (z. B. ABE) stehen Ihnen dort als Download zur Verfügung.

Bitte lesen und verstehen Sie alle Anweisungen, Sicherheitshinweise und Warnungen in dieser Anbauanleitung vor Montage und Nutzung des Produkts, um Verletzungen und Schäden zu vermeiden. Bewahren Sie diese Anbauanleitung als Referenz auf.

Dieses Produkt wurde für Fahrzeuge im Werkzustand entwickelt. Die Kompatibilität mit Original-Zubehörteilen bzw. den Zubehörteilen anderer Hersteller kann nicht gewährleistet werden.

Diese Anbauanleitung ist nach unserem derzeitigen Kenntnisstand verfasst worden. Rechtliche Ansprüche auf Richtigkeit bestehen nicht. Fehler und Irrtümer vorbehalten. Technische und gestalterische Änderungen sind vorbehalten. Das Urheberrecht liegt bei SW-MOTECH.

## SICHERHEITSWARNUNGSSYMBOL

 Dieses Warnsymbol wird in dieser Anbauanleitung verwendet, um vor tödlichen Gefahren, Verletzungen oder anderen Gefahren zu warnen. Die Wörter **GEFAHR**, **WARNUNG** oder **VORSICHT** werden mit diesem Warnsymbol verwendet, um wichtige Sicherheitshinweise und Informationen in Bezug auf die Montage und Nutzung dieses Produkts zu übermitteln. Diese Wörter zusammen mit dem Sicherheitswarnsymbol bedeuten:

**▲ GEFAHR:** Weist auf eine gefährliche Situation hin, die zum Tod oder zu schweren Verletzungen führt, wenn sie nicht vermieden wird!

**▲ WARNUNG:** Weist auf eine gefährliche Situation hin, die zum Tod oder zu schweren Verletzungen führen kann, wenn sie nicht vermieden wird!

**▲ VORSICHT:** Weist auf eine gefährliche Situation hin, die zu leichten oder mittelschweren Verletzungen führen kann, wenn sie nicht vermieden wird!

**▲ HINWEIS:** Wichtige Informationen, jedoch nicht in Bezug auf Todes- oder Verletzungsgefahr (nur Sachschäden)!

## ALLGEMEINE HINWEISE

**▲ WARNUNG:** Die Montage und/oder Wartung dieses Produkts erfordert fortgeschrittene technische Fähigkeiten, geeignetes Werkzeug und ein gutes Verständnis der Werkzeugnutzung und Drehmomentangaben. Zu Ihrer eigenen Sicherheit empfiehlt SW-MOTECH, die Montage und/oder Wartung von einer qualifizierten und zertifizierten Zweiradwerkstatt durchführen zu lassen.

**▲ WARNUNG:** Wenn Sie sich für die Eigenmontage dieses Produkts entscheiden, lesen Sie vor Montage und Nutzung die Anbauanleitung sorgfältig und vollständig durch und befolgen Sie alle Anweisungen, um schwere oder tödliche Verletzungen zu vermeiden. Beachten Sie bei der Montage und Verwendung auch alle relevanten Informationen im Fahrzeughandbuch. **WENN SIE EINEN TEIL DIESER ANBAUANLEITUNG NICHT VERSTEHEN ODER EINE ERKLÄRUNG EINER ANWEISUNG BENÖTIGEN, VERSUCHEN SIE NICHT DIESES PRODUKT ZU MONTIEREN, OHNE SW-MOTECH UM HILFE ZU FRAGEN!**

**VORBEREITUNG:** Lesen Sie die Anbauanleitung aufmerksam und stellen Sie sicher, dass alle Teile der Stückliste vorhanden sind.

**▲ VORSICHT:** Achten Sie auf den sicheren Stand Ihres Fahrzeugs. Schalten Sie den Motor ab und ziehen Sie den Zündschlüssel. Lassen Sie den Motor/Auspuff bei Bedarf abkühlen. Klemmen Sie die Batterie bei Arbeiten an der Elektrik ab. Verwenden Sie nur geeignetes Werkzeug und tragen Sie während der Montage und Wartung immer eine Schutzbrille und Handschuhe. Lassen Sie sich bei der Montage und Wartung von einer zweiten Person helfen.

**MONTAGE:** Alle vom Fahrzeug entfernten Teile und Verbindungen müssen gemäß den Angaben des Fahrzeugherstellers wieder eingebaut oder durch von SW-MOTECH gelieferte Teile und Hardware ersetzt werden.

**▲ WARNUNG:** Sichern Sie alle Gewinde, sofern nicht anders angegeben, mit mittelstarker, flüssiger Schraubensicherung.

**▲ GEFAHR:** Von SW-MOTECH nicht definierte Anzugsdrehmomente müssen Sie vom Fahrzeughersteller oder von einer zertifizierten Motorradwerkstatt beziehen.

**FUNKTIONSKONTROLLE:** Stellen Sie nach der Montage sicher, dass keine beweglichen Teile blockiert sind und die Funktion des Fahrzeugs nicht gestört wird. Kabel und Schläuche dürfen nicht scheuern und/oder geklemmt werden.

**▲ WARNUNG:** Führen Sie vor Fahrtbeginn eine umfassende Funktionskontrolle durch. Prüfen Sie nach den ersten 50 km und dann regelmäßig das Anzugsmoment aller Verbindungen und den festen Sitz des Produkts. Montiertes Zubehör kann das Fahrverhalten und die Stabilität des Fahrzeugs verändern.



SW-MOTECH GmbH & Co. KG  
Ernteweg 7-10  
35282 Rauschenberg  
Deutschland



[info@sw-motech.com](mailto:info@sw-motech.com)  
[www.sw-motech.com](http://www.sw-motech.com)



Beachten Sie in dem Abschnitt MONTAGE vorkommenden Symbole und deren Bedeutung. Wenn im Abschnitt MONTAGE die Bezeichnung OEM vorkommt, müssten die Vorgaben des Fahrzeugherstellers beachtet und angewandt werden.



Bei Fragen steht Ihnen unser Kundendienst sowie unsere Distributoren gerne zur Verfügung. Unsere Telefonnummer sowie eine Liste unserer Distributoren finden Sie in unserem Webshop: [www.sw-motech.com](http://www.sw-motech.com)















**Keine Schraubensicherung verwenden:** Weist darauf hin, dass an der Stelle keine flüssige Schraubensicherung notwendig ist.



**Handfest anziehen:** Weist darauf hin, dass das Anbauteil vorsichtig mit der Hand angezogen werden muss.

STÜCKLISTE - ANBAUANLEITUNG LESEN UND AUFBEWAHREN!

<p><b>1</b></p>	<p><b>1</b></p> 	<p><b>2</b></p> 	<p><b>3</b></p> 	<p><b>4</b></p> 	<p><b>5</b></p> 	<p><b>6</b></p> 
	<p>HDG.00.220.002L.02</p> <p> 1/1</p>	<p>HDG.00.220.002R.02</p> <p> 1/1</p>	<p>HDG.00.220.008L.02</p> <p> 1/1</p>	<p>HDG.00.220.008R.02</p> <p> 1/1</p>	<p>HDG.00.220.009.02</p> <p> 4/4</p>	<p>M3,5 x 12 SC.ST.035.012.02</p> <p> 8/8</p>



**⚠️ WARNUNG: Tragen Sie immer Augen- und Handschutz!**  
**⚠️ WARNUNG: Verwenden Sie immer geeignetes Werkzeug!**

**⚠️ HINWEIS:** Die Montage ist linksseitig dargestellt. Wiederholen Sie die Montage mit den entsprechenden Teilen auf der rechten Seite.

**⚠️ HINWEIS:** Achten Sie auf die L-Kennzeichnung (links) bzw. R-Kennzeichnung (rechts) der Kunststoffkappen (3/4).  
 Stecken Sie die Kunststoffkappen (3/4) in die Öffnungen der Adventure Handprotector-Schalen (1/2).

Verschrauben Sie die Adventure Handprotector-Schalen (1/2) an den Bügeln (\*).

Ziehen Sie die Schrauben (5) vorsichtig handfest (max. 1 Nm) an.

**⚠️ WARNUNG: Zu festes Anziehen kann die Kunststoffteile beschädigen!**

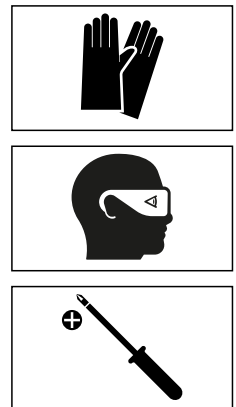
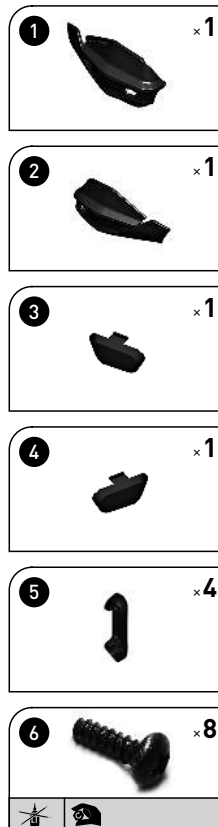



**PRODUKTSPEZIFISCHE HINWEISE**

**⚠ HINWEIS:** Beachten Sie die landesspezifischen Vorschriften für Zulassung/Betrieb Ihres Fahrzeugs bzw. anwendbare TÜV-Vorschriften. Lassen Sie eintragungspflichtige Teile nach Montage durch Ihre Prüfstelle in die Fahrzeugpapiere eintragen.

Item number: HDG.00.220.10000/B

Revision: 01 · Date: 12 - 2023

## Adventure handguard shell set

 ~ 0.25 h.EASY      DIFFICULT

**ENGLISH** Thank you for choosing this premium product from SW-MOTECH. Visit our online shop for more information (e.g. model assignments). Required documents (e.g. national type approval) are available there for you to download.

Please read and understand all the instructions, safety information and warnings in these mounting instructions before mounting and using the product in order to avoid injury and damage. Keep these mounting instructions for reference.

This product was developed for vehicles in factory condition. Compatibility with original accessories or accessories from other manufacturers cannot be guaranteed.

These mounting instructions have been prepared to the best of our current knowledge. No legal claims relating to accuracy can be made. Errors and omissions excepted. We reserve the right to make technical and design changes. The copyright is held by SW-MOTECH.

## SAFETY WARNING SYMBOL

 This warning symbol is used in these mounting instructions to warn of deadly dangers, injuries or other hazards. The words DANGER, WARNING or CAUTION are used as part of this warning symbol to convey important safety messages and information relating to the installation and use of this product. These words, together with the safety warning symbol, mean:

 **DANGER:** Indicates a hazardous situation which, if not avoided, will result in death or serious injury!

 **WARNING:** Indicates a hazardous situation which, if not avoided, may result in death or serious injury!

 **CAUTION:** Indicates a hazardous situation which, if not avoided, may result in minor or moderate injury!

 **NOTE:** Important information, but not relating to a risk of death or injury (property damage only)!

## GENERAL INFORMATION

 **WARNING:** Assembly and/or maintenance of this product requires advanced technical skill, appropriate tools, and a good understanding of tool usage and torque specifications. For your own safety, SW-MOTECH recommends having the assembly and/or maintenance carried out by a qualified and certified motorcycle workshop.

 **WARNING:** If you do choose to assemble this product yourself, carefully and fully read the mounting instructions before assembly and use, and follow all instructions to avoid serious injury or death. Also observe all relevant information in the vehicle manual when mounting or using the product. IF YOU DO NOT UNDERSTAND ANY PART OF THESE MOUNTING INSTRUCTIONS OR NEED AN EXPLANATION AS TO A SPECIFIC INSTRUCTION, DO NOT ATTEMPT TO INSTALL THIS PRODUCT WITHOUT CONSULTING SW-MOTECH FOR ASSISTANCE!

**PREPARATION:** Read the mounting instructions carefully and make sure that all parts on the parts list are available.

 **CAUTION:** Ensure that your vehicle is standing securely. Switch off the engine and remove the ignition key. Allow the engine/exhaust to cool down if necessary. Disconnect the battery when working on the electrical system. Only use proper tools and always wear safety goggles and gloves during assembly and maintenance. Have a second person help you with assembly and maintenance.

**ASSEMBLY:** All parts and connections removed from the vehicle must be reinstalled according to the vehicle manufacturer's specifications or replaced with parts and hardware supplied by SW-MOTECH.

 **WARNING:** Secure all threads with a medium-strength liquid threadlocker, unless otherwise specified.

 **DANGER:** Tightening torques not defined by SW-MOTECH must be obtained from the vehicle manufacturer or a certified motorbike workshop.

**FUNCTIONAL CHECK:** After mounting the product, ensure that no moving parts are obstructed and that the function of the vehicle is not impeded. Cables and hoses must not rub against each other and/or be hindered in any way.

 **WARNING:** Carry out a comprehensive functionality check before you start to drive. Check the tightening torque of all connections and the tight fit of the product after the first 50 km and then at regular intervals. Mounted accessories can change the handling and stability of the vehicle.



SW-MOTECH GmbH & Co. KG  
Ernteweg 7-10  
35282 Rauschenberg  
Germany



info@sw-motech.com  
www.sw-motech.com

## LEGEND OVERVIEW - READ AND KEEP MOUNTING INSTRUCTIONS!



Take note of the symbols and what they mean in the ASSEMBLY section. If the term OEM appears in the ASSEMBLY section, the vehicle manufacturer's specifications must be observed and applied.



If you have any questions, please don't hesitate to contact our Customer Service team or our distributors. You can find our telephone number and a list of our distributors in our online shop:

**[www.sw-motech.com](http://www.sw-motech.com)**















**Do not use thread lock:** Indicates that no liquid thread lock should be used at this point.



**Tighten by hand:** Indicates that the attachment must be carefully tightened by hand.

**PARTS LIST - READ AND KEEP MOUNTING INSTRUCTIONS!**

<b>1</b>						
	HDG.00.220.002L.02	HDG.00.220.002R.02	HDG.00.220.008L.02	HDG.00.220.008R.02	HDG.00.220.009.02	M3,5 x 12 SC.ST.035.012.02
	 1/1	 1/1	 1/1	 1/1	 4/4	 8/8



**▲ WARNING: Always wear eye and hand protection!**  
**▲ WARNING: Always use the proper tools!**

**△ NOTE:** Assembly is shown on the left side. Repeat the assembly with the corresponding parts on the right.

**△ NOTE:** Pay attention to the L marking (left) or R marking (right) of the plastic caps [3/4]. Insert the plastic caps [3/4] into the openings of the Adventure hand-guard shells [1/2].

Screw the Adventure hand-guard shells [1/2] onto the brackets [\*]. Carefully tighten the screws [5] hand-tight (max. 1 Nm).

**▲ WARNING: Tightening too tightly can damage the plastic parts!**

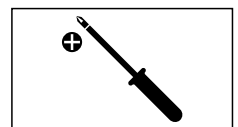
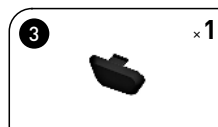

**PRODUCT-SPECIFIC NOTES**

**⚠ NOTE:** *Observe the country-specific regulations for the registration/operation of your vehicle or applicable TÜV regulations. After assembly, have parts that are subject to registration entered in the vehicle documents by your test centre.*

Número de artículo: HDG.00.220.10000/B

Revisión: 01 · Fecha: 12 - 2023

## Cubiertas para protectores de manos Adventure

 ~ 0.25 h.FÁCIL     COMPLICADO

**ESPAÑOL** · Gracias por elegir este producto de primera calidad de SW-MOTECH. Visite nuestra tienda online para obtener más información (p. ej., sobre el uso de los modelos). Desde esa página podrá descargar los documentos que necesite (por ejemplo, la homologación nacional de tipo).

Para evitar lesiones y daños, asegúrese de leer y comprender todas las instrucciones, advertencias de seguridad y precauciones de este manual antes de montar y utilizar el producto. Guarde estas instrucciones de montaje como referencia.

Este producto ha sido desarrollado para vehículos en condiciones de fábrica. No se garantiza la compatibilidad con los accesorios originales o de otros fabricantes.

Estas instrucciones de montaje se han redactado de acuerdo con nuestros conocimientos actuales. No hay reclamaciones legales de corrección. Salvo errores y omisiones. Nos reservamos el derecho a realizar cambios técnicos y de diseño. Los derechos de autor pertenecen a SW-MOTECH.

## SÍMBOLO DE ADVERTENCIA DE SEGURIDAD

 Este símbolo de advertencia se utiliza en estas instrucciones de montaje para advertir de peligros mortales, lesiones u otros riesgos. Las palabras PELIGRO, ATENCIÓN o PRECAUCIÓN se utilizan con este símbolo de advertencia para transmitir importantes avisos de seguridad e información relacionada con el montaje y uso de este producto. Estas palabras, junto con el símbolo de advertencia de seguridad, significan:

 **PELIGRO:** Indica una situación de peligro que, si no se evita, provoca lesiones graves o incluso la muerte.

 **ATENCIÓN:** Indica una situación de peligro que, si no se evita, puede provocar lesiones graves o incluso la muerte.

 **PRECAUCIÓN:** Indica una situación de peligro que, si no se evita, puede provocar lesiones leves o de gravedad media.

 **NOTA:** Información importante, pero que no está relacionada con un riesgo de lesiones o muerte (solo daños materiales).

## INDICACIONES GENERALES

 **ATENCIÓN:** El montaje y/o mantenimiento de este producto requiere conocimientos técnicos avanzados, las herramientas apropiadas, un buen manejo de dichas herramientas y conocer las especificaciones de los pares de apriete. Por su propia seguridad, SW-MOTECH recomienda que el montaje y/o el mantenimiento los realice un taller de motocicletas cualificado y certificado.

 **ATENCIÓN:** Si elige ensamblar este producto usted mismo, antes de montarlo y usarlo, lea las instrucciones de montaje detenidamente y en su totalidad, y siga todas las indicaciones para evitar lesiones graves o mortales. Cuando monte y utilice el producto, tenga también en cuenta toda la información relevante que figure en el manual del vehículo. SI NO ENTIENDE ALGUNA PARTE DE ESTAS INSTRUCCIONES DE MONTAJE O NECESITA ALGUNA ACLARACIÓN, NO INTENTE INSTALAR ESTE PRODUCTO SIN CONSULTAR A SW-MOTECH PARA OBTENER AYUDA.

**PREPARACIÓN:** Lea atentamente las instrucciones de montaje y asegúrese de que todas las piezas de la lista de piezas están presentes.

 **PRECAUCIÓN:** Asegúrese de que su vehículo esté estacionado de manera segura. Apague el motor y retire la llave de encendido. Deje que el motor o el escape se enfrien si es necesario. Desconecte la batería cuando trabaje en el sistema eléctrico. Utilice únicamente las herramientas adecuadas y use siempre gafas de seguridad y guantes al realizar el montaje y las tareas de mantenimiento. Pida a otra persona que le ayude con el montaje y el mantenimiento.

**MONTAJE:** Todas las piezas y conexiones retiradas del vehículo deben ser reinstaladas de acuerdo con las especificaciones del fabricante del vehículo o sustituidas por piezas y herrajes suministrados por SW-MOTECH.

 **ATENCIÓN:** Asegure todas las roscas con fijador de roscas líquido de resistencia media, a menos que se especifique lo contrario.

 **PELIGRO:** Los pares de apriete no definidos por SW-MOTECH deben obtenerse del fabricante del vehículo o de un taller de motocicletas certificado.

**COMPROBACIÓN FUNCIONAL:** Después del montaje, asegúrese de que no haya piezas móviles bloqueadas y de que no se altere el funcionamiento del vehículo. Los cables y tubos no deben rozarse ni quedar pinzados.

 **ATENCIÓN:** Realice una comprobación exhaustiva del funcionamiento antes de iniciar la marcha. Tras los primeros 50 km y, después, con regularidad, compruebe el par de apriete de todas las conexiones y que el producto está firmemente sujeto. Los accesorios instalados pueden cambiar el comportamiento de conducción y la estabilidad del vehículo.



SW-MOTECH GmbH & Co. KG  
Ernteweg 7-10  
35282 Rauschenberg  
Alemania



info@sw-motech.com  
www.sw-motech.com



Preste atención a los símbolos que figuran en la sección de MONTAJE y su significado. Cuando, en la sección de MONTAJE, aparecen las siglas OEM, se deberán seguir y aplicar las especificaciones del fabricante del vehículo.



Si tiene alguna pregunta, nuestro servicio de atención al cliente y nuestros distribuidores estarán encantados de prestarle ayuda. Encontrará nuestro número de teléfono y una lista de nuestros distribuidores en nuestra tienda online:

[www.sw-motech.com](http://www.sw-motech.com)















**No usar fijador de roscas:** Indica que no es necesario usar fijador de roscas líquido en este punto.



**Apretar a mano:** Indica que el componente se debe apretar cuidadosamente a mano.



LISTA DE PIEZAS - LEE Y CONSERVA LAS INSTRUCCIONES DE MONTAJE!

<p><b>1</b></p>	<p><b>1</b></p>  <p>HDG.00.220.002L.02</p> <p> 1/1</p>	<p><b>2</b></p>  <p>HDG.00.220.002R.02</p> <p> 1/1</p>	<p><b>3</b></p>  <p>HDG.00.220.008L.02</p> <p> 1/1</p>	<p><b>4</b></p>  <p>HDG.00.220.008R.02</p> <p> 1/1</p>	<p><b>5</b></p>  <p>HDG.00.220.009.02</p> <p> 4/4</p>	<p><b>6</b></p>  <p>M3,5 x 12 SC.ST.035.012.02</p> <p> 8/8</p>
-----------------	--	--	--	--	---	--



**⚠ ATENCIÓN: ¡Use siempre protección de ojos y manos!**  
**⚠ ATENCIÓN: ¡Utilice siempre herramientas adecuadas!**

**⚠ NOTA:** El montaje se muestra en el lado izquierdo. Repetir el montaje con las piezas correspondientes en el lado derecho.

**⚠ NOTA:** Fijese en las marcas L (izquierda) y R (derecha) de los tapones de plástico (3/4).  
 Inserte los tapones de plástico (3/4) en las aberturas de los protectores de manos Adventure (1/2).

Atornille los protectores de manos Adventure (1/2) a los soportes (\*).  
 Apriete a mano y con precaución los tornillos (5) (máx. 1 Nm).

**⚠ ATENCIÓN: ¡Apretarlos demasiado puede dañar las piezas de plástico!**

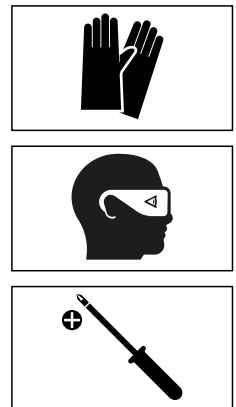
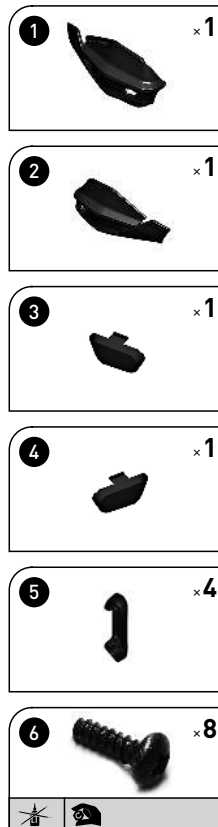

**INDICACIONES ESPECÍFICAS DEL PRODUCTO**

**⚠ NOTA:** *Tenga en cuenta las normas específicas del país para la matriculación/uso de su vehículo o las normas aplicables de la ITV. En caso de piezas con registro obligatorio, su organismo de inspección debe registrarlas tras el montaje en los documentos del vehículo.*

Numéro d'article: HDG.00.220.10000/B

Révision: 01 · Date: 12 - 2023

## Set de coques protège-mains Adventure

 ~ 0.25 h.FACILE      DIFFICILE

**FRANÇAIS** · Nous vous remercions d'avoir choisi ce produit haut de gamme de SW-MOTECH. Visitez notre boutique en ligne pour plus d'informations (par exemple affectation des modèles). Les documents nécessaires (par exemple ABE) y sont disponibles en téléchargement.

**Veillez lire et prendre en compte toutes les instructions, les consignes de sécurité et les avertissements contenus dans ce manuel de montage avant de monter et d'utiliser le produit afin d'éviter toute blessure ou tout dommage. Veuillez conserver la notice d'utilisation pour référence.**

**Ce produit a été développé pour des véhicules en configuration d'usine. Nous ne sommes pas en mesure d'assurer la compatibilité avec les pièces de rechange originales ou les pièces de rechange d'autres fabricants.**

**La présente notice d'installation a été élaborée conformément à nos connaissances actuelles. Il n'existe aucun droit juridique à l'exactitude des informations qu'elle contient. Sous réserve d'erreurs et de fautes. Sous réserve de modifications techniques et conceptuelles. SW-MOTECH détient les droits d'auteur.**

## SYMBOLE D'AVERTISSEMENT DE SÉCURITÉ

 Ce symbole d'avertissement est utilisé dans ces instructions de montage pour mettre en garde contre des dangers mortels, de blessures ou d'autres risques. Les mots DANGER, ATTENTION ou RECOMMANDATION sont utilisés avec ce symbole d'avertissement pour transmettre des consignes de sécurité et des informations importantes concernant le montage et l'utilisation de ce produit. Ces mots, associés au symbole d'avertissement de sécurité, signifient :

 **DANGER** : signale une situation dangereuse pouvant entraîner la mort ou des blessures graves si elle n'est pas évitée !

 **ATTENTION** : signale une situation dangereuse pouvant entraîner la mort ou des blessures graves si elle n'est pas évitée !

 **PRUDENCE** : Indique une situation dangereuse susceptible d'entraîner des blessures de gravité réduite ou moyenne si elle se présente !

 **REMARQUE** : Informations importantes, mais qui n'entraînent pas de risque de décès ou de blessure (dommages matériels uniquement).

## REMARQUES GÉNÉRALES

 **ATTENTION** : le montage et/ou l'entretien de ce produit nécessite des compétences techniques avancées, des outils appropriés et une bonne compréhension de l'utilisation des outils et des indications de réglage. Pour votre propre sécurité, SW-MOTECH recommande de confier le montage et/ou l'entretien à un atelier de réparation de deux-roues qualifié et certifié.

 **ATTENTION** : si vous décidez de monter vous-même ce produit, lisez attentivement et intégralement les instructions de montage avant le montage et l'utilisation et suivez toutes les instructions afin d'éviter des blessures graves ou mortelles. Lors du montage et de l'utilisation, tenez également compte de toutes les informations pertinentes du manuel du véhicule. **SI VOUS NE COMPRENEZ PAS UNE PARTIE DE CE MANUEL D'INSTALLATION OU SI VOUS AVEZ BESOIN D'EXPLICATIONS CONCERNANT UNE INSTRUCTION, N'ESSAYEZ PAS D'INSTALLER CE PRODUIT SANS DEMANDER DE L'AIDE À SW-MOTECH !**

**PRÉPARATION** : Veuillez lire attentivement les instructions de montage et assurez-vous que tous les éléments de la liste de pièces sont présents.

 **PRUDENCE** : veillez à ce que votre véhicule soit bien stable. Éteignez le moteur et retirez la clé de contact. Laissez refroidir le moteur/l'échappement si nécessaire. Débranchez la batterie lorsque vous travaillez sur le système électrique. Utilisez uniquement des outils appropriés et portez toujours des lunettes de protection et des gants pendant le montage et l'entretien. Faites-vous aider par une deuxième personne lors du montage et de l'entretien.

**MONTAGE** : Toutes les pièces et connexions retirées du véhicule doivent être réinstallées conformément aux instructions du fabricant du véhicule ou remplacées par des pièces et du matériel fournis par SW-MOTECH.

 **ATTENTION** Sauf indication contraire, sécurisez tous les filetages avec du frein filet liquide de force moyenne.

 **DANGER** : Les couples de serrage non définis par SW-MOTECH doivent être obtenus auprès du constructeur du véhicule ou d'un atelier de réparation de motos certifié.



**CONTRÔLE DU FONCTIONNEMENT** : Après le montage, assurez-vous qu'aucune pièce mobile n'est bloquée et que le fonctionnement du véhicule n'est pas perturbé. Les câbles et les tuyaux ne doivent pas frotter et/ou être coincés.

 **ATTENTION** : Effectuez un contrôle de fonctionnement complet avant de commencer à rouler. Après les 50 premiers kilomètres, puis régulièrement, vérifiez le couple de serrage de tous les raccords et la bonne fixation du produit. Les accessoires montés peuvent modifier le comportement sur la route et la stabilité du véhicule.



SW-MOTECH GmbH & Co. KG  
Ernteweg 7-10  
35282 Rauschenberg  
Allemagne



 [info@sw-motech.com](mailto:info@sw-motech.com)  
 [www.sw-motech.com](http://www.sw-motech.com)



Vous trouverez les symboles et leur signification dans la section MONTAGE. Si le terme OEM apparaît dans la section MONTAGE, il faut respecter et appliquer les consignes du fabricant du véhicule.



Si vous avez des questions, notre service clientèle ainsi que nos distributeurs se tiennent à votre disposition. Vous trouverez notre numéro de téléphone ainsi que la liste de nos distributeurs sur notre boutique en ligne : [www.sw-motech.com](http://www.sw-motech.com)



**Ne pas utiliser de frein filet :** signifie que l'utilisation d'un frein filet liquide n'est pas nécessaire à ce stade.



**Serrer manuellement :** indique que la pièce de montage doit être serrée à la main avec précaution.

LISTE DES PIÈCES - LIRE ET CONSERVER LES INSTRUCTIONS DE MONTAGE!

1

1



HDG.00.220.002L.02

 1/1

2



HDG.00.220.002R.02

 1/1

3



HDG.00.220.008L.02

 1/1

4



HDG.00.220.008R.02

 1/1

5



HDG.00.220.009.02

 4/4

6



M3,5 x 12  
SC.ST.035.012.02

 8/8

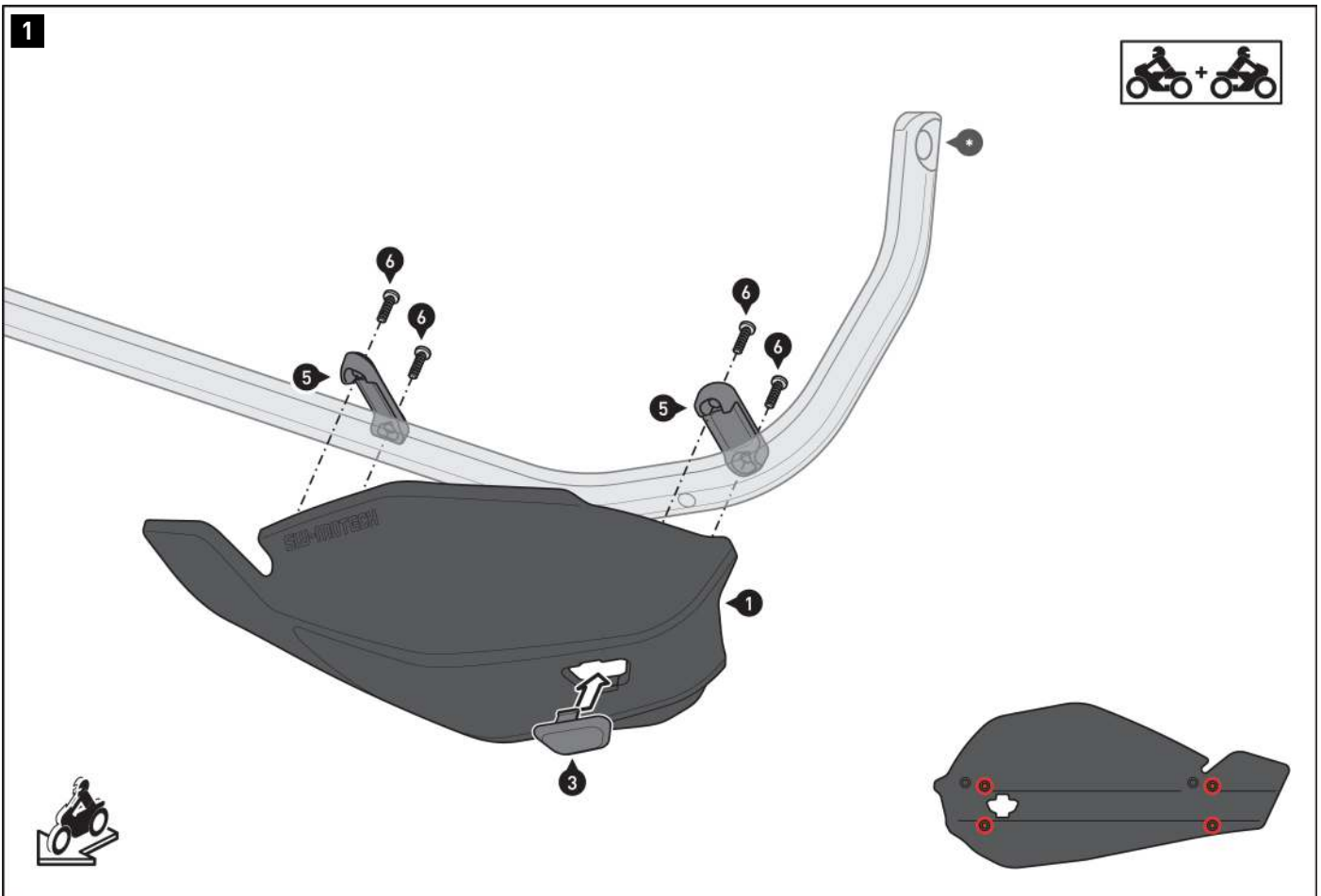

**⚠ ATTENTION : portez toujours des lunettes et des gants de protection !**  
**⚠ ATTENTION : Utilisez toujours des outils appropriés !**

**⚠ REMARQUE :** Le montage est représenté côté gauche. Répétez le montage avec les pièces correspondantes du côté droit.

**⚠ REMARQUE :** Faites attention au marquage L (gauche) ou R (droite) des capuchons en plastique (3/4). Insérez les capuchons en plastique (3/4) dans les ouvertures des coques des protège-mains Adventure (1/2).

Vissez les coques des protège-mains Adventure (1/2) sur les brides de fixation (\*).

Serrez les vis (5) à la main avec précaution (max. 1 Nm).

**⚠ ATTENTION : Un serrage trop fort peut endommager les pièces en plastique !**

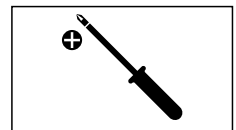
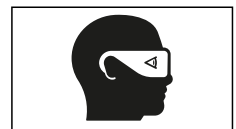

**REMARQUES SPÉCIFIQUES AU PRODUIT**

**⚠ REMARQUE** : Respectez les réglementations spécifiques au pays pour l'immatriculation/l'exploitation de votre véhicule ou les réglementations TÜV applicables. Après le montage, faites inscrire les pièces soumises à immatriculation dans les papiers du véhicule par votre centre de contrôle.



Numero di articolo: HDG.00.220.10000/B

Revisione: 01 · Data: 12 - 2023

## Set di calotte paramani Adventure

 ~ 0.25 h.FACILE      DIFFICILE

**ITALIANO** -Grazie per aver scelto questo prodotto premium di SW-MOTECH. Visita il nostro negozio online per ulteriori informazioni (ad es. per la compatibilità con i vari modelli). I documenti richiesti (ad es. certificato di omologazione nazionale) possono essere scaricati qui.

**Si prega di leggere attentamente le avvertenze di sicurezza e le istruzioni per il montaggio prima di montare e utilizzare il prodotto, al fine di evitare eventuali lesioni e danni. Conserva queste istruzioni per il montaggio come riferimento futuro.**

**Questo prodotto è stato sviluppato per veicoli in condizioni di fabbrica. La compatibilità con gli accessori originali o di altri produttori non può essere garantita.**

**Queste istruzioni per il montaggio sono state redatte in base alle nostre conoscenze attuali. Non sussistono pretese di correttezza giuridiche. Salvo errori ed omissioni. Ci riserviamo il diritto di apportare modifiche tecniche e di design. Copyright SW-MOTECH.**

## SIMBOLO DI SICUREZZA

 Questo simbolo di avvertenza è usato nelle presenti istruzioni di montaggio per segnalare pericoli mortali, rischio di lesioni o altri pericoli. Le parole "PERICOLO", "AVVERTENZA" O "ATTENZIONE" sono utilizzate con questo simbolo di avvertenza per trasmettere importanti istruzioni di sicurezza e informazioni relative al montaggio e all'uso di questo prodotto. Queste parole, utilizzate insieme al simbolo di avvertenza, significano:

**▲ PERICOLO:** indica una situazione di pericolo che, se non evitata, può causare morte o lesioni gravi!

**▲ AVVERTENZA:** indica una situazione di pericolo che, se non evitata, può causare morte o lesioni gravi!

**▲ ATTENZIONE:** indica una situazione di pericolo che, se non evitata, può provocare lesioni lievi o di entità moderata!

**▲ AVVISO:** indica informazioni importanti che non riguardano il rischio di morte o di lesioni (riguardano unicamente il rischio di danni materiali)!

## INFORMAZIONI GENERALI

**▲ AVVERTENZA:** il montaggio e/o la manutenzione di questo prodotto richiedono competenze tecniche avanzate, strumenti adeguati e una buona conoscenza dell'uso della strumentazione e delle indicazioni relative alle coppie di serraggio. Per ragioni di sicurezza, SW-MOTECH raccomanda di far eseguire il montaggio e/o la manutenzione presso un'officina per motociclette qualificata e certificata.

**▲ AVVERTENZA:** se si decide di installare questo prodotto in autonomia, leggere attentamente le istruzioni per il montaggio prima del montaggio e dell'uso e seguire tutte le avvertenze per evitare lesioni gravi o mortali. Durante il montaggio e l'uso, seguire anche tutte le istruzioni pertinenti contenute nel manuale del veicolo. **SE NON SI COMPRENDONO TALI ISTRUZIONI, ANCHE SOLO IN PARTE, O SE SONO NECESSARI CHIARIMENTI, NON CERCARE DI MONTARE IL PRODOTTO IN AUTONOMIA SENZA CHIEDERE IL SUPPORTO DI SW-MOTECH!**

**PREPARAZIONE:** leggere attentamente le istruzioni per il montaggio e assicurarsi che siano disponibili tutti i componenti contenuti nella lista.

**▲ ATTENZIONE:** assicurarsi che il veicolo sia perfettamente fermo. Spegner il motore e togliere la chiave. Se necessario, lasciar raffreddare il motore/lo scarico. Scollegare la batteria quando si interviene sull'impianto elettrico. Usare esclusivamente strumenti idonei e indossare sempre occhiali e guanti protettivi durante le operazioni di montaggio e manutenzione. Chiedere aiuto a una seconda persona durante le fasi di montaggio e manutenzione.

**MONTAGGIO:** tutti i componenti e i collegamenti rimossi dal veicolo devono essere reinstallati secondo le specifiche del produttore del veicolo o sostituiti con componenti e attrezzatura forniti da SW-MOTECH.

**▲ AVVERTENZA:** fissare tutte le filettature con frenafili liquido a media resistenza, se non diversamente specificato.

**▲ PERICOLO:** le coppie di serraggio non definite da SW-MOTECH devono essere richieste al costruttore del veicolo o a un'officina certificata.

**CONTROLLO DI FUNZIONALITÀ:** dopo il montaggio accertarsi che non vi siano parti mobili bloccate e che il funzionamento del veicolo non sia compromesso. I cavi e i tubi flessibili non devono sfregare e/o essere schiacciati.

**▲ AVVERTENZA:** eseguire un controllo completo delle funzioni prima di mettersi alla guida. Controllare la coppia di serraggio di tutti i collegamenti e la tenuta del prodotto dopo i primi 50 km e in seguito regolarmente. Gli accessori montati possono modificare la maneggevolezza e la stabilità del veicolo.



SW-MOTECH GmbH & Co. KG  
Ernteweg 7-10  
35282 Rauschenberg  
Germania



info@sw-motech.com  
www.sw-motech.com



Consultare i simboli e il loro significato nella sezione MONTAGGIO. Se nella sezione montaggio compare la sigla OEM, è necessario rispettare e applicare le specifiche del produttore del veicolo.



Per qualsiasi domanda, non esitare a contattare il nostro servizio clienti o i nostri distributori. Il nostro numero di telefono e l'elenco dei nostri distributori sono disponibili nel nostro negozio online:  
**[www.sw-motech.com](http://www.sw-motech.com)**









**Non utilizzare il frenaflessi:** segnala di non dover utilizzare il frenaflessi liquido in quel determinato punto.



**Serrare a mano:** indica che l'elemento di fissaggio deve essere serrato a mano con cautela.

ELENCO DELLE PARTI - LEGGI E CONSERVA LE ISTRUZIONI DI MONTAGGIO!

<b>1</b>	<b>1</b> 	<b>2</b> 	<b>3</b> 	<b>4</b> 	<b>5</b> 	<b>6</b> 
	HDG.00.220.002L.02 📦 1/1	HDG.00.220.002R.02 📦 1/1	HDG.00.220.008L.02 📦 1/1	HDG.00.220.008R.02 📦 1/1	HDG.00.220.009.02 📦 4/4	M3,5 x 12 SC.ST.035.012.02 📦 8/8

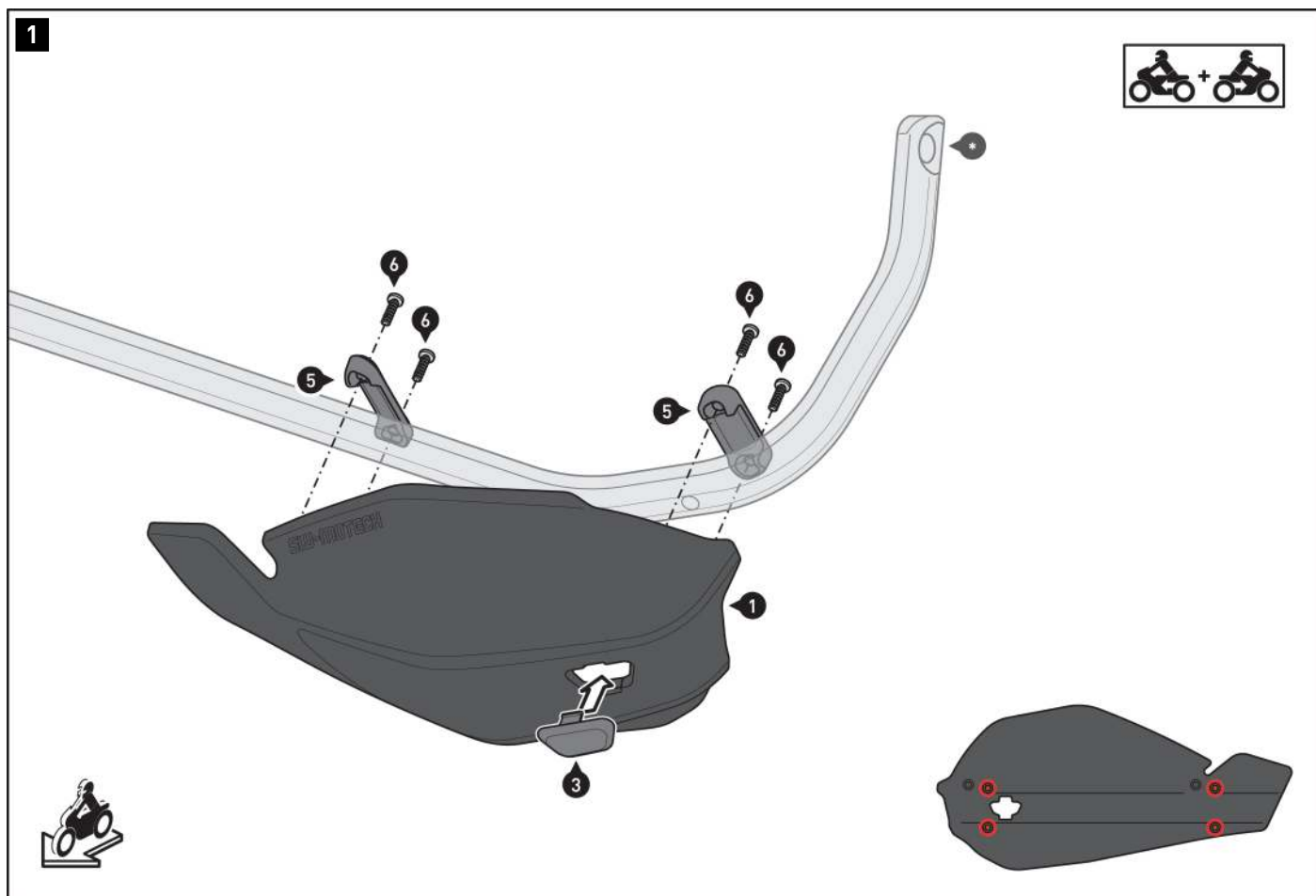

**⚠ AVVERTENZA: indossare sempre le protezioni per gli occhi e per le mani!**  
**⚠ AVVERTENZA: Utilizzare sempre strumenti adeguati!**

**⚠ AVVISO:** le operazioni di montaggio ivi illustrate riguardano il lato sinistro del veicolo. Ripetere il montaggio sul lato destro del manubrio seguendo le medesime istruzioni e avvalendosi delle parti corrispondenti.

**⚠ AVVISO:** prestare attenzione alla marcatura L (sinistra) o alla marcatura R (destra) dei cappucci in plastica (3/4) Inserire i cappucci in plastica (3/4) nelle apposite aperture delle calotte paramani Adventure (1/2).

Avvitare le calotte paramani Adventure (1/2) sulle staffe (\*). Stringere con cautela le viti (5) manualmente (max. 1 Nm).

**⚠ AVVERTENZA: un serraggio eccessivo può danneggiare le parti in plastica!**

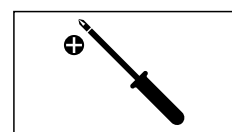
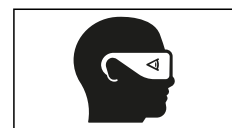
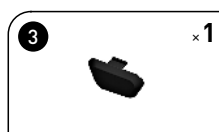

**AVVERTENZE SPECIFICHE DEL PRODOTTO**

**⚠ AVVISO** :Rispettare le normative specifiche del paese per l'immatricolazione/l'uso del veicolo o le normative TÜV applicabili. Dopo il montaggio, far inserire le parti soggette a omologazione nei documenti del veicolo dal proprio centro di test.