

MJ-906S USER MANUAL

ACCESSORY/STRUCTURE

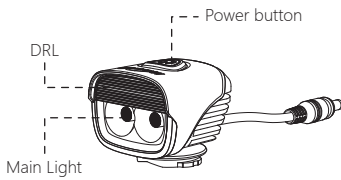

HOW TO INSTALL

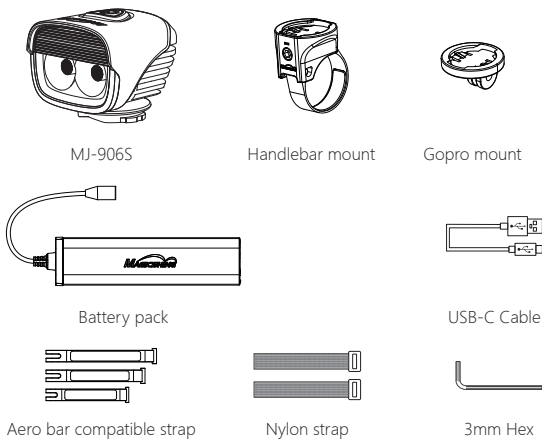
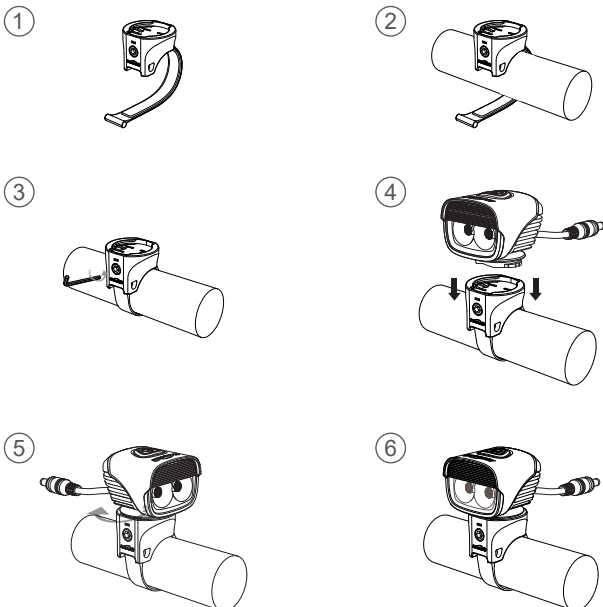

HOW TO INSTALL BATTERY PACK

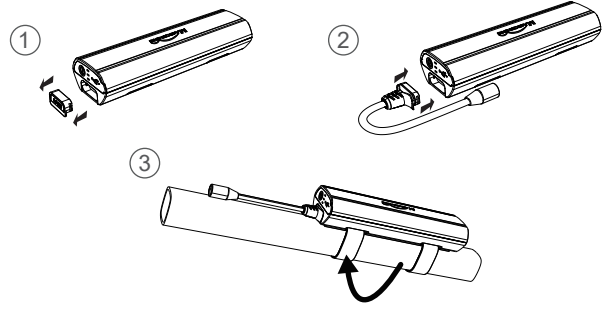

BATTERY INDICATOR

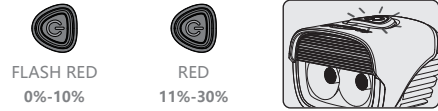

HOW TO RECHARGE

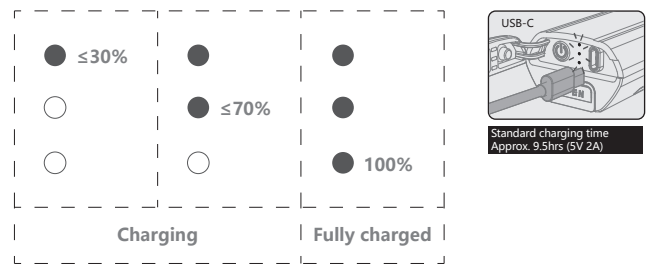

SWITCHING THE LIGHTING MODE

Hold 1s power button to turn on/off

Modes Switch:

From bicycle light mode to E-bike light mode:

Long press power button for 8 seconds until it flashes.

From E-bike light mode to bicycle light mode:



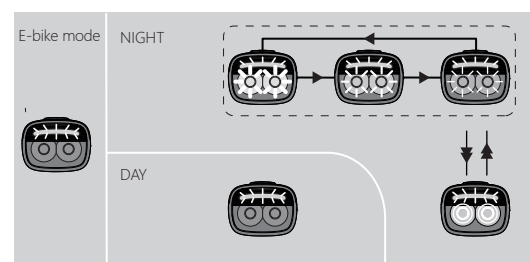
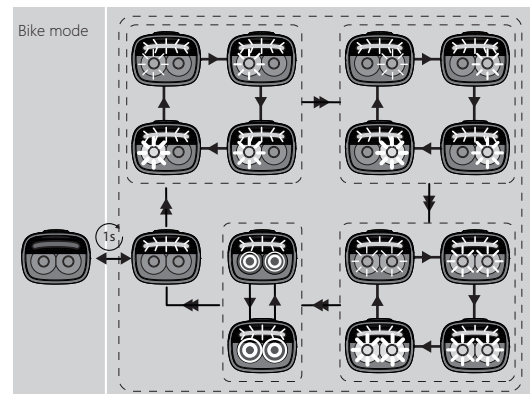





Long press power button for 8 seconds until it lights constantly.





▶ Click ▶▶ Double clicks 1s Hold 1 second

LUMENS/RUN TIME

Bike mode

BRIGHTNESS	DRL	/	/	/
 	35	/	/	/
	50:00	/	/	/
CONSTANT	ECONOMICAL	LOW	MID	HIGH
 	600	1200	1600	2300
	12:30	06:00	04:00	02:06
 	800	1800	2500	4500
	11:30	05:30	03:10	02:20
FLASH	FLASH 1	FLASH 2	/	/
 	0-2300	0-600	/	/
	04:30	07:48	/	/

E-bike mode

NIGHT	HIGH	MID	LOW	FLASH
	4500	2500	1800	0-1800
DAY	DRL	/	/	/
	35	/	/	/

 The data is tested in laboratory conditions, and the actual performance can change according to the environment.

OPTIONAL PARTS

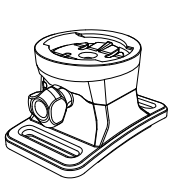

Helmet mount

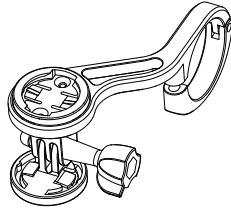

TTA front mount

*Adaptable accessories (sold separately)

WARNING



EN WARRANTY

The Magicshine lighting system is warranted for 24 months from the date of purchase.

If you register the lighting system on the Magicshine website you will receive a bonus 6 month warranty.

Battery packs and AC adapters have a 6 month warranty, however, there is no bonus warranty available.

The warranty is limited to defects in material and workmanship on the lighting system itself, the battery pack and the AC adapter.

The warranty is only valid if the affected parts have not been tampered with and there is no intentional damage. Please keep your proof of purchase in a safe place. Proof of purchase must be presented in the event of any claim. Please contact the specialist retailer from whom you purchased the device for complaint or warranty claim.

Alternatively, you can send your complaint or claim directly to Magicshine at

Tel: (+86) 755-295 536 69

Fax: (+86)755-275 897 77

E-mail: support@magicshine.com (order from Magicshine.com online store)

service@magicshine.com (order from other sales channels)

In the event of a justified warranty claim and delivery of a replacement device, you will only be entitled to a model available when replacing. The manufacturer retains the right to make technical modifications.

ANSI FL 1 STANDARD

