



Revision: 1.3 - 01/23/2013

WARNING! Engine guards are in no way intended to provide bodily protection for the rider and/or passenger. The motorcycle operator assumes all responsibility for any effect this product may have on motorcycle handling. Engine guards are for cosmetic use only.

INSTRUCTIONS:

- 1. Protect the rear portion of the front fender with a towel or other thick, soft cloth.**
 - 2. Remove the OEM engine guards if they have been installed on the motorcycle. Your new Barons engine guard will fasten to the frame at the same points as the OEM guard and will use the same hardware.**
- Or, if OEM engine guards are not present, Perform the following two steps:**
- a. Remove the large button-head 6mm Allen bolts located on the frame just forward of the floorboard mounting brackets.**
 - b. Remove the acorn nuts on both the right and left upper frame bolts located approximately 6 inches above the large Allen head bolts.**
- CAUTION! Do not remove these bolts completely. Instead, slide them inward until the ends of the bolts are flush with the hole surface. If the motorcycle is not equipped with these bolts, please see your local Yamaha dealer and ask for (2) of part number 92017-10030-00.**
- 3. With the lower brackets facing the bike's rear, carefully slide the engine guard into the space between the front fender and the radiator.**
 - 4. Lift the guard a few inches until the lower mounting brackets align with the bolt holes just forward of the driver floorboard mounting brackets.**
 - 5. Insert a large 6mm button head Allen bolt into the hole on each side of the frame and finger tighten. If the brackets are too wide, they will squeeze together when the Allen bolts are tightened.**
 - 6. Rotate the engine guard until the upper guard mounting brackets are in a vertical position on each side, and just to the rear of the radiator. Due to production line tolerances in both the motorcycle and the engine guard, the mounting brackets may be too wide or too narrow for the frame. If this is the case**
 - a. Remove the guard from the motorcycle.**
 - b. Place the guard on a flat, firm surface. Place a towel or similar protection between the guard and this surface.**
 - c. Use a hard rubber mallet, or place a block of wood over each bracket, and tap with a hammer until the brackets are far enough apart to install the guard.**
 - 7. Push the upper frame bolts through the holes on the lower ends of the brackets, and finger tighten an acorn nut on each bolt.**

Note: Due to metal spring-back after the manufacturing process is complete, the upper bracket mounting holes may not line up correctly with the upper frame bolts. To remedy this, use a ratchet-type nylon motorcycle tie-down wrapped around the guard's upper and lower bars to help pull the upper bar down into proper

Our install guides provide a basic outline on the proper installation of our products. Further tuning and/or fitment may be required. Barons bears no responsibility on installation costs associated with this product.
© 2013 Barons Custom Accessories

alignment. Refer to the illustration below.

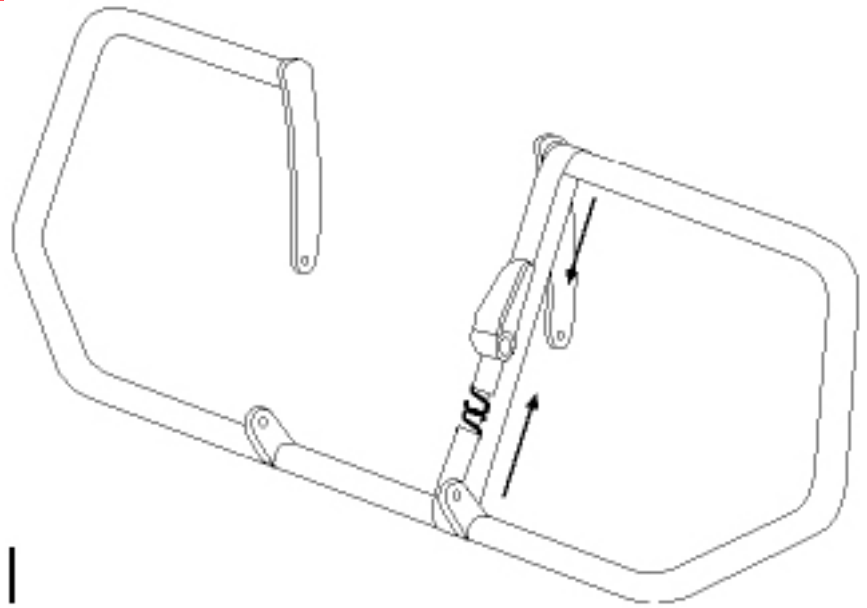

8. Tighten all nuts and bolts. The upper frame mount bolts may be difficult to hold in place while tightening the acorn nuts. This task is made easier by using an air impact wrench to tighten these bolts.

9. Remove the protection on the front fender and you're ready to ride. CAUTION!!! You must re-tighten all four of the engine guard mounting bolts after 100 miles of riding!

Note: Due to production line tolerances in both the engine guard and the motorcycle, the guard may come into contact with the floorboards during installation. We strongly suggest that you apply masking tape to the leading edges of both floorboards to avoid the possibility of scratching the guard's lower tube.

If, for any reason, the engine guard contacts the floorboards after installation, we recommend that you fasten the guard to a solid, secure object using a rope or tie-down. GENTLY back up the motorcycle, pulling the guard forward and away from the floorboards.

Warning: No warranties or guaranties regarding personal safety are expressed or implied. Unlike the driver floorboards, which fold up if they contact the ground while leaning excessively in a corner, these engine guards will not fold up. In point of fact, these engine guards can, and under the proper circumstances will, lift the motorcycle off the road causing potential loss of control if the motorcycle is leaned too aggressively in a corner.